



FIMER



**Solar inverter  
solutions  
for building  
applications**



# **Table of contents**

- 04 Our brand, our roots, our future**
- 06 A global reality, Made in Italy**
- 08 Residential solutions**
- 26 Commercial and Industrial solutions**
- 44 FIMER PowerGain**
- 46 Export limitation solution**
- 47 Monitoring and control solutions**
- 58 Life cycle services for solar inverters**
- 60 Honoring our Customers globally**

# Our brand, our roots, our future

Our vision is to shape a **new and powerful energy model** that uses the power of the sun to drive progress and prosperity for a cleaner and sustainable world. As a global leader in solar inverter technology, with a 100% Italian supply chain, we have the energy to make positive change happen. We are committed to building value for future generations using **clean energy** as a response to the world's growing energy needs.

We do it in a sustainable, innovative and dynamic way, through a complete portfolio of photovoltaic solutions for energy conversion and storage, and e-mobility solutions for electric vehicles. Through such extensive range of products, we share our **brave, new vision** with the world.

Our DNA and our core values all reflect our vision and mission:

## Responsibility

Every day we strive to offer our customers reliable and state-of-the-art solutions and to build a world where energy is used in a sustainable manner for future generations.



## Passion

We never stop. We focus on expanding and improving our know-how and expertise to drive growth. This is reflected in the passion we put into our work, into the solutions we create and into the technologies we design every day and in the Service that we provide to our customers.

## Professionalism

We are close to our customers, to ensure the quality and distinctive excellence of our solutions. We like to leave a mark. A guarantee for those who invest in our expertise and professionalism.



## Flexibility

We are quick to interpret changes and fast at adapting to market developments. We are able to constantly improve and work hard to be number one when it counts, where it counts. Our skills and our ability to make the most of change are an integral part of our way of being.

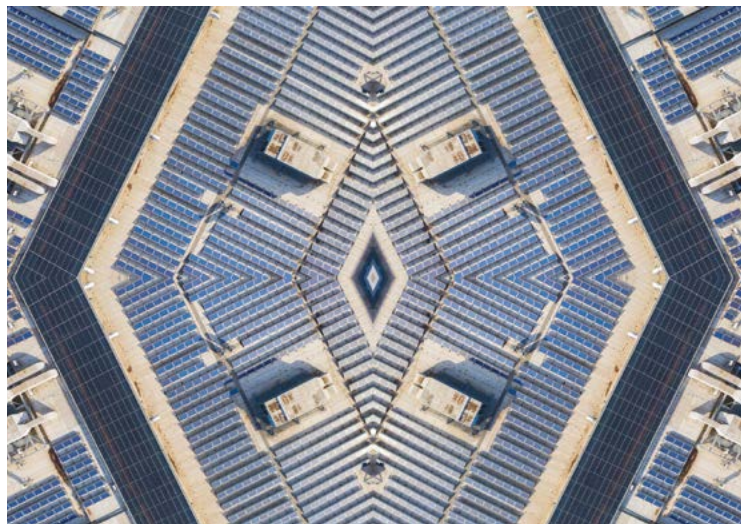



## Vimercate Headquarters

All over the world, our work contributes to reducing CO<sup>2</sup> emissions. Our global Headquarters in Vimercate are designed to set an example of efficiency, sustainability and technology that has made us one of the few companies with Zero Impact, powered by a 1 MW photovoltaic system constructed with highly sustainable materials. Our HQ in Vimercate features an area specializing in cutting-edge carpentry and logistics. We constantly invest in high-precision machines and technologies, to guarantee the quality of our solutions manufactured both in Vimercate and Terranuova Bracciolini.

## Terranuova R&D and manufacturing site

Our Terranuova Bracciolini branch features an innovative research and development department, several technologically advanced laboratories and highly specialized production areas, making FIMER an Italian technology leader.



# A Global reality, Made in Italy

Operating in over 20 countries, and with one of the broadest solutions portfolio, we are now one of the leading manufacturers of energy conversion systems, ready to listen and face every challenge in every corner of the world. Research & Development, the main production plants and all

the main decision-making processes take place in Italy. We have a common goal that goes beyond all borders: to expand Italian technological excellence to the whole world.

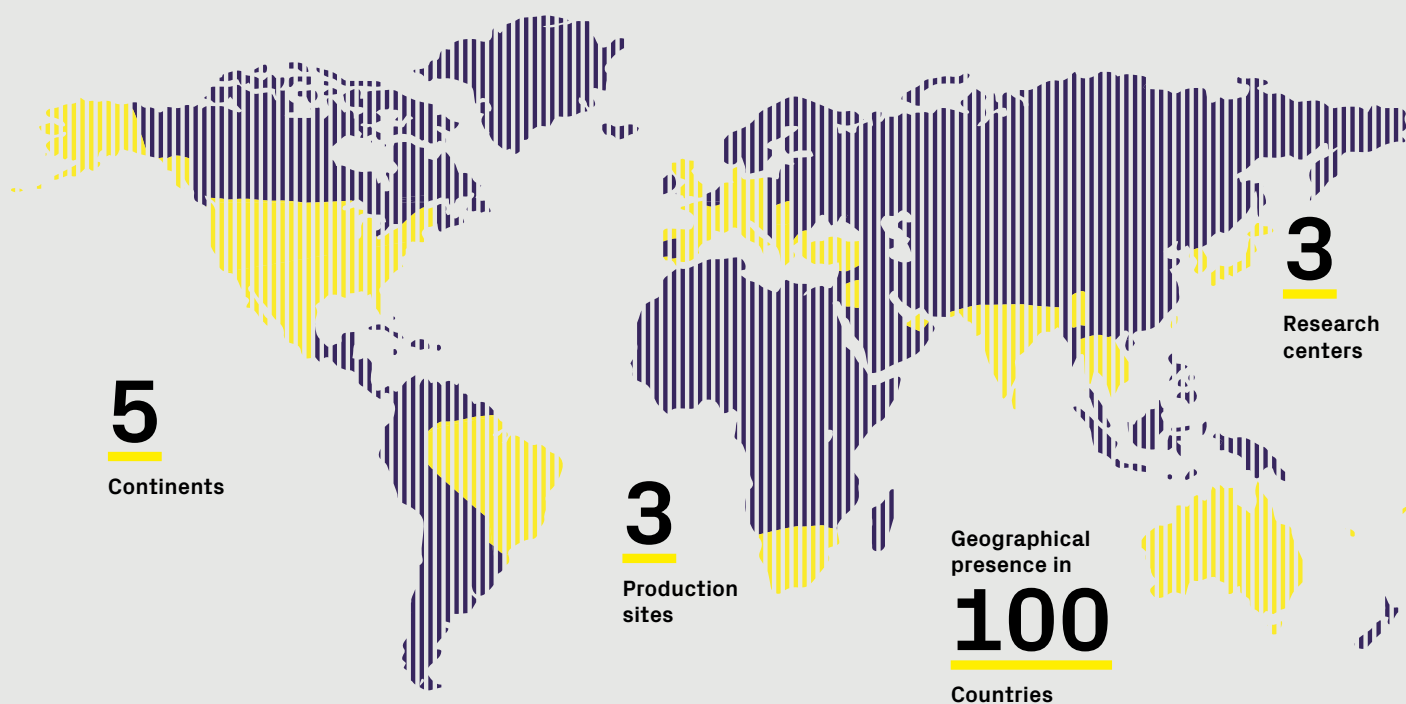

Our solutions are based on over 80 years of experience and continuous technological advances. Standardized, certified and expandable: the production processes applied and the plants in which the inverters are manufactured play a key role in ensuring the high quality of our offer. Engineering excellence, rigorous quality and testing standards are corroborated by our global certifications; we strive to achieve the highest levels of quality in every aspect of our business.

## **Certified Partners to ensure high quality and a reliable service at a global level.**

The excellence of the Made in Italy concept also extends to our Service Partner Network. We select the Partners according to their professionalism and reliability and we offer pre- and post-sales services, Customer support, webinars and constant education. We have a network of certified and trained partners, who know the market inside out and are available to propose our solar and e-mobility solutions, tailored to local regulations and specific needs.

# From residential to decentralized commercial and industrial applications, our inverters fit any plant

Photovoltaic systems have proven more and more to be one of the most clean and convenient energy sources worldwide. FIMER is proud to play an important role in driving the solar innovation, providing its customers with smart solutions that are every day more connected to the digital grid. Whether in residential applications, in modern smart homes that require batteries to store excess energy or even in commercial or industrial decentralized power plants, FIMER offers the most cost-effective solution.

## **String inverters for residential applications – the efficient choice for home energy**

Consisting of both single- and small three-phase inverters, FIMER's offering can fit the needs of any household that is looking to save on their energy bills while making an environmentally friendly choice.

Always in line with our customer's needs, our devices feature enhanced smart functionalities thanks to which homeowners can control and monitor their energy production and own consumption through any mobile device.

## **String inverters with integrated energy storage – welcome to the age of the prosumer**

FIMER's inverters with integrated energy storage represent the line that separates a conscious consumer from a modern prosumer. Thanks to a modern integrated Li-Ion battery, it is now possible to store excess energy and use it when most needed. Households are now the owners of the energy produced from their system, deciding the appropriate moment to use it, without wasting a watt.

## **String inverters for commercial and industrial applications – bright future ahead for decentralized power generation**

The future of energy is anchored to decentralized production from renewable sources like photovoltaics that have already driven a massive transformation in the way energy is produced, consumed and provided through modern transportation grids.

Photovoltaics are already one of most cost-effective energy sources in many regions of the world and when they complement with digital technologies the benefits for users are at the maximum scale.

Thanks to our inverter solutions for decentralized commercial and industrial applications, many companies can achieve greater efficiency and sustainable growth, today as tomorrow.

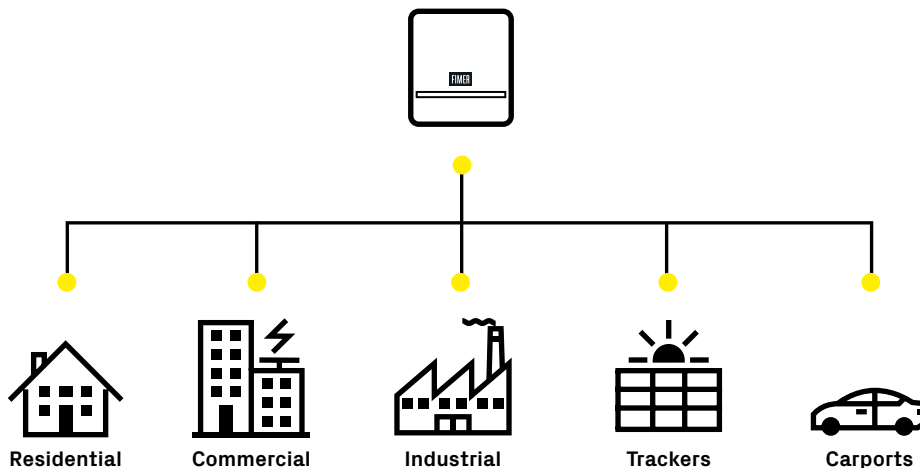





# Residential solutions

You can count on smart technology that connects with your smart residential buildings.

FIMER offers a broad line of residential inverters that can meet the needs of modern homes.

Our portfolio includes single-phase and small three-phase string inverters as well as energy storage solutions that make the most of your solar system.

Thanks to FIMER's solutions for residential solar buildings PV installers can benefit from a quick and easy installation and commissioning while end users can benefit from an optimized user experience thanks to control and monitoring

features that allow the energy management flow in smart homes by simply using any Wi-Fi enabled device (PC, smartphones or tablets).

The future-proof and flexible design of our solutions simplify the integration with smart building automation devices, smart grid integration and with third party monitoring and control systems.



# FIMER string inverters

## UNO-DM-PLUS-Q

### 1.2 to 6.0 kW

The UNO-DM-TL-PLUS-Q single-phase inverter family, with power ratings from 1.2 to 6.0 kW, is the optimal solution for residential installations.

#### **One size fits all**

The design wraps FIMER's quality and engineering into a lightweight and compact package thanks to technological choices optimized for installations with different orientation. All power ratings share the same overall volume, allowing higher performance in a minimum space, and are available with both single (from 1.2 to 3.0 kW models) and dual (from 3.3 to 6.0 kW models) Maximum Power Point Trackers.

#### **Easy to install, fast to commission**

The presence of Plug and Play connectors, both on the DC and AC side, as well as the wireless communication, enable a simple, fast and safe installation without the need of opening the front cover of the inverter.

The featured easy commissioning routine removes the need for a long configuration process, resulting in lower installation time and costs.

Improved user experience thanks to the built-in User Interface (UI) which enables access to features such as advanced inverter configuration settings, dynamic feed-in control and load manager, from any WLAN enabled device (smartphone, tablet or PC).

#### **Smart capabilities**

The embedded logging capabilities and direct transferring of the data to Internet (via Ethernet or WLAN) allow customers to enjoy the whole Aurora Vision remote monitoring experience.

The advanced communication interfaces (WLAN, Ethernet, RS485) combined with an efficient Modbus (RTU/TCP) communication protocol, Sunspec compliant, allow the inverter to be easily integrated within any smart environment and with third party monitoring and control systems.

A complete set of control functions with the embedded efficient algorithm, enabling dynamic control of the feed-in (i.e. zero injection), make the inverter suitable for worldwide applications in compliance with regulatory norms and needs of the utilities.

#### **Energy Viewer**

This new tool allows residential customers to remotely monitor the performance of their own solar plant and provides all information necessary to increase energy self-reliance and self-sufficiency.

#### **Highlights**

- Wireless access to the embedded Web User Interface
- Easy commissioning capability
- Future-proof with embedded connectivity for smart building and smart grid integration
- Dynamic feed-in control (for instance "zero injection")
- Remote firmware upgrade for inverter and components
- Modbus TCP/RTU Sunspec compliant
- Lifetime free of charge access to Aurora Vision
- FIMER PowerGain yield optimization
- Energy community ready

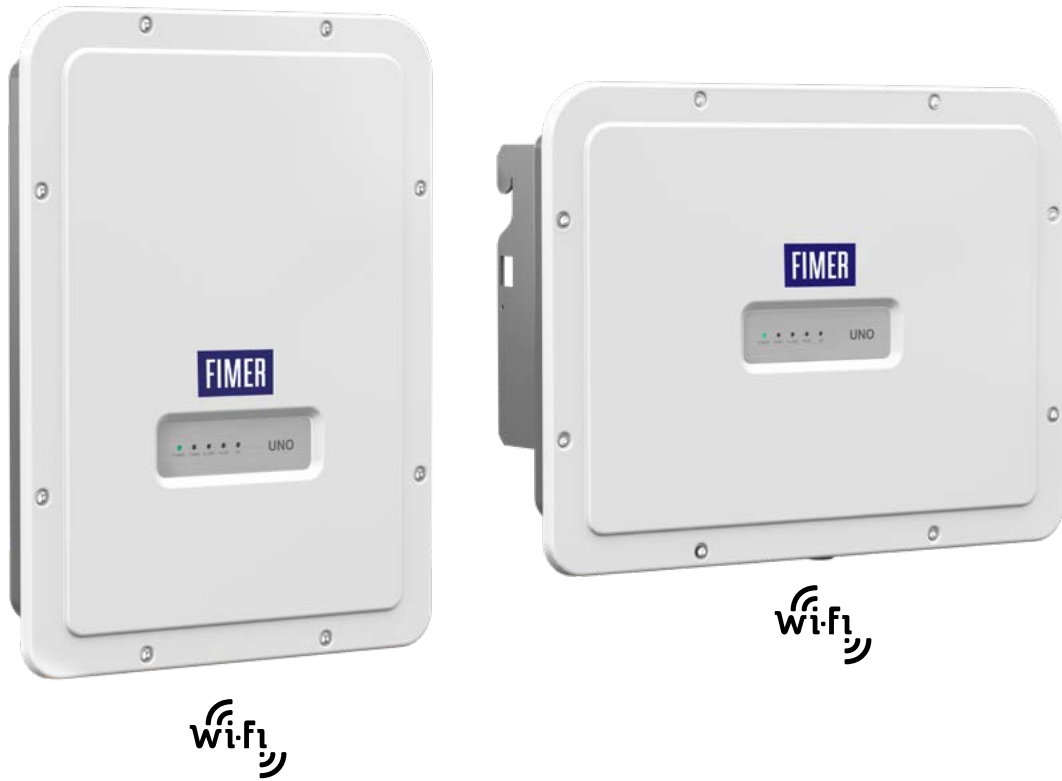

FIMER UNO-DM-PLUS-Q block diagram

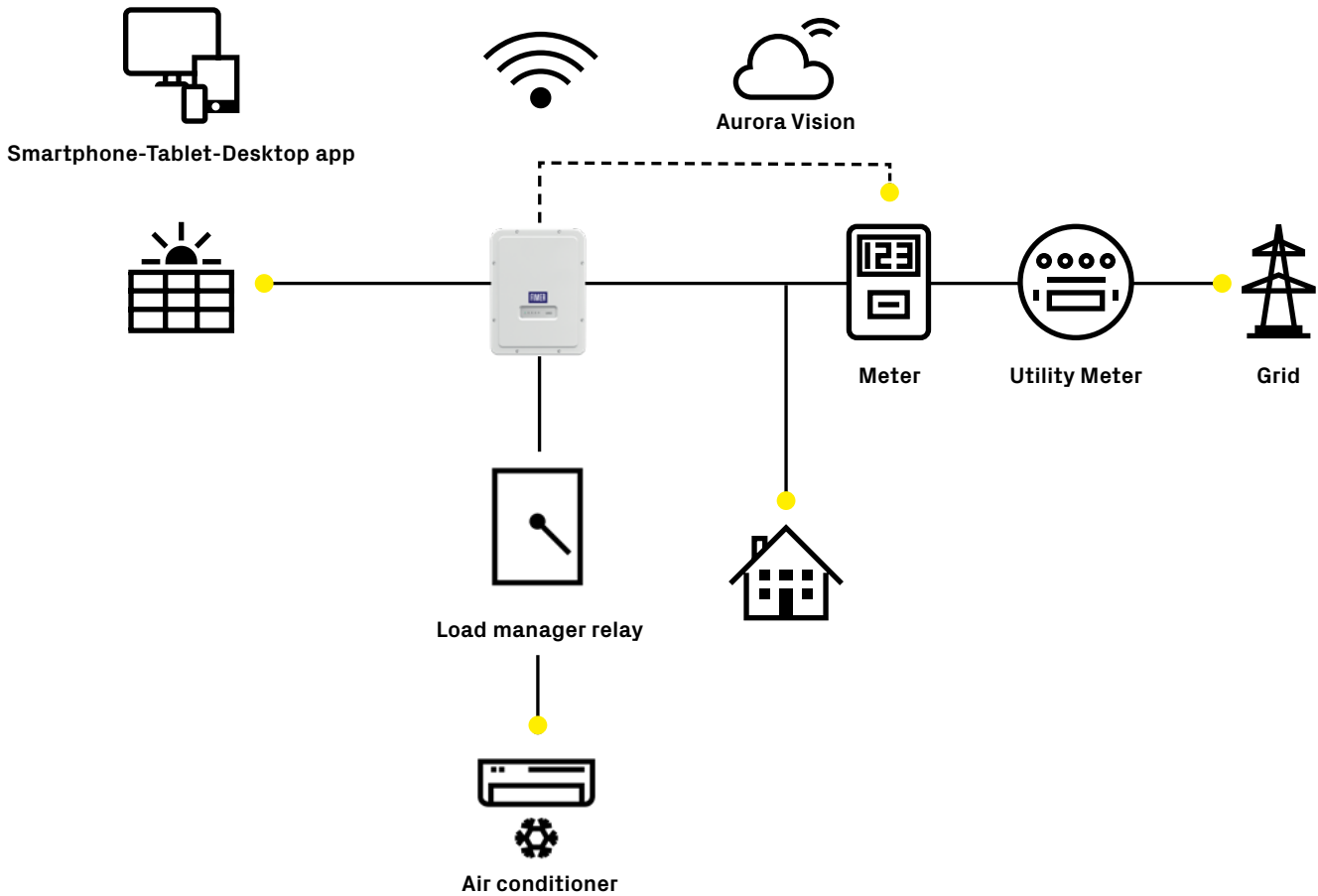

## Technical data and types

Type code	UNO-DM-1.2-TL-PLUS-Q	UNO-DM-2.0-TL-PLUS-Q	UNO-DM-3.0-TL-PLUS-Q	UNO-DM-3.3-TL-PLUS-Q
<b>Input side</b>				
Absolute maximum DC input voltage ( $V_{max,abs}$ )	600 V			
Start-up DC input voltage ( $V_{start}$ )	120 V (adj. 120...150 V)	150 V (adj. 120...250 V)	150 V (adj. 120...250 V)	200 V (adj. 120...350 V)
Operating DC input voltage range ( $V_{dcmin}...V_{dcmax}$ )	0.7 x $V_{start}$ ...580 V (min 90 V)			
Rated DC input voltage ( $V_{dc,r}$ )	185 V	300 V	300 V	360 V
Rated DC input power ( $P_{dc,r}$ )	1500 W	2500 W	3300 W	3500 W
Number of independent MPPT	1	1	1	2
Maximum DC input power for each MPPT ( $P_{MPPT,max}$ )	1500 W	2500 W	3300 W	2000 W
DC input voltage range with parallel configuration of MPPT at $P_{dc,r}$	100...530 V	210...530 V	320...530 V	170...530 V
DC power limitation with parallel configuration of MPPT	N/A	N/A	N/A	Linear derating from Max to Null [530 V ≤ $V_{MPPT}$ ≤ 580 V] 2000 W
DC power limitation for each MPPT with independent configuration of MPPT at $P_{dc,r}$ , max unbalance example	N/A	N/A	N/A	[200 V ≤ $V_{MPPT}$ ≤ 530 V] the other channel: $P_{dc,r}$ -2000 W [112 V ≤ $V_{MPPT}$ ≤ 530 V]
Maximum DC input current ( $I_{dc,max}$ ) / for each MPPT ( $I_{MPPT,max}$ )	10.0 A	10.0 A	10.0 A	20.0/10.0 A
Maximum input short circuit current for each MPPT	12.5 A	12.5 A	12.5 A	20.0 A
Number of DC input pairs for each MPPT	1			
DC connection type <sup>3)</sup>	Quick Fit PV Connector			
<b>Input protection</b>				
Reverse polarity protection	Yes, from limited current source			
Input over voltage protection for each MPPT-varistor	Yes			
Photovoltaic array isolation control	According to local standard			
DC switch rating for each MPPT (version with DC switch)	25 A / 600 V			
<b>Output side</b>				
AC grid connection type	Single-phase			
Rated AC power ( $P_{ac,r}$ @ $\cos\phi=1$ )	1200 W	2000 W	3000 W	3300 W
Maximum AC output power ( $P_{ac,max}$ @ $\cos\phi=1$ )	1200 W	2000 W	3000 W	3300 W
Maximum apparent power ( $S_{max}$ )	1200 VA	2000 VA	3000 VA	3300 VA
Rated AC grid voltage ( $V_{ac,r}$ )	230 V			
AC voltage range <sup>2)</sup>	180...264 V			
Maximum AC output current ( $I_{ac,max}$ )	5.5 A	10.0 A	14.5 A	14.5 A
Contributory fault current	10.0 A	12.0 A	16.0 A	16.0 A
Rated output frequency ( $f_o$ ) <sup>3)</sup>	50/60 Hz			
Output frequency range ( $f_{min}...f_{max}$ ) <sup>3)</sup>	47...53/57...63 Hz			
Nominal power factor and adjustable range	> 0.995, adj. ± 0.1 - 1 (over/under excited)			
Total current harmonic distortion	< 3%			
AC connection type	Female connector from panel			
<b>Output protection</b>				
Anti-islanding protection	According to local standard			
Maximum external AC overcurrent protection	10.0 A	16.0 A	16.0 A	20.0 A
Output overvoltage protection - varistor	2 (L - N / L - PE)			
<b>Operating performance</b>				
Maximum efficiency ( $\eta_{max}$ )	94.8%	96.7%	96.7%	97.0%
Weighted efficiency (EURO/CEC)	92.0%/-	95.0%/-	95.0%/-	96.5% / -
Feed in power threshold	8 W			
Night consumption	<0.4 W			
<b>Embedded communication</b>				
Embedded communication interface <sup>4)</sup>	Wireless			
Embedded communication protocol	ModBus TCP (SunSpec)			
Commissioning tool	Web User Interface, Aurora Manager Lite			
Monitoring	Plant Portfolio Manager, Plant Viewer, Plant Viewer for Mobile, Energy Viewer			

## Technical data and types

Type code	UNO-DM-1.2-TL-PLUS-Q	UNO-DM-2.0-TL-PLUS-Q	UNO-DM-3.0-TL-PLUS-Q	UNO-DM-3.3-TL-PLUS-Q
<b>Optional board UNO-DM-COM kit</b>				
Optional communication interface	RS485 (use with meter for dynamic feed-in control), Alarm/Load manager relay, Remote ON/OFF			
Optional communication protocol	ModBus RTU (SunSpec), Aurora Protocol			
<b>Optional board UNO-DM-PLUS Ethernet COM kit</b>				
Optional communication interface	Ethernet, RS485 (use with meter for dynamic feed-in control), Alarm/Load manager relay, Remote ON/OFF			
Optional communication protocol	ModBus TCP (SunSpec), ModBus RTU (SunSpec), Aurora Protocol			
<b>Environmental</b>				
Ambient temperature range	-25...+60°C / -13...140°F with derating above 50°C/122°F	-25...+60°C / -13...140°F with derating above 50°C/122°F	-25...+60°C / -13...140°F con derating above 50°C/122°F	-25...+60°C / -13...140°F with derating above 50°C/122°F
Relative humidity	0...100 % condensing			
Acoustic noise emission level	50 dBA @ 1 m			
Maximum operating altitude without derating	2000 m / 6560 ft			
<b>Physical</b>				
Environmental protection rating	IP 65			
Cooling	Natural			
Dimension (H x W x D)	553 x 418 x 175 mm / 21.8" x 16.5" x 6.9"			
Weight	15 kg / 33 lbs			
Mounting system	Wall bracket			
<b>Safety</b>				
Isolation level	Transformerless			
Marking	CE , RCM			
Safety and EMC standard	IEC/EN 62109-1, IEC/EN 62109-2, AS/NZS 4777.2, EN 61000-6-1, EN 61000-6-2, EN 61000-6-3, EN 61000-6-4, EN 61000-3-2, EN 61000-3-3			IEC/EN 62109-1, IEC/EN 62109-2, EN 61000-6-1, EN 61000-6-2, EN 61000-6-3, EN 61000-6-4, EN 61000-3-11, EN 61000-3-12
Grid standard (check your sales channel for availability) <sup>5)</sup>	CEI 0-21, DIN V VDE V 0126-1-1, VDE-AR-N 4105, G83/2, G59/3, G98/1, G99/1, EN 50549-1, RD 413, ITC-BT-40, AS/NZS 4777.2, IEC 61727, IEC 62116			CEI 0-21, DIN V VDE V 0126-1-1, VDE-AR-N 4105, G83/2, G59/3, G98/1, G99/1, RD 413, ITC-BT-40, AS/NZS 4777.2, IEC 61727, IEC 62116
<b>Available products variants</b>				
Standard	UNO-DM-1.2-TL-PLUS-B-Q	UNO-DM-2.0-TL-PLUS-B-Q	UNO-DM-3.0-TL-PLUS-B-Q	UNO-DM-3.3-TL-PLUS-B-Q
With DC switch	UNO-DM-1.2-TL-PLUS-SB-Q	UNO-DM-2.0-TL-PLUS-SB-Q	UNO-DM-3.0-TL-PLUS-SB-Q	UNO-DM-3.3-TL-PLUS-SB-Q

- 1) "Refer to the document "String inverter – Product Manual appendix" available at [www.fimer.com](http://www.fimer.com) to know the brand and the model of the quick fit connector"
- 2) The AC voltage range may vary depending on specific country grid standard
- 3) The frequency range may vary depending on specific country grid standard; CE is valid for 50 Hz only
- 4) As per IEEE 802.11 b/g/n standard
- 5) Further grid standard will be added, please refer to FIMER Solar page for

further details

#### Remarks:

- **Designed and manufactured in Italy**
- **Features not specifically listed in the present data sheet are not included in the product**

## Technical data and types

Type code	UNO-DM-3.6-TL-PLUS-Q	UNO-DM-4.0-TL-PLUS-Q	UNO-DM-4.6-TL-PLUS-Q	UNO-DM-5.0-TL-PLUS-Q	UNO-DM-6.0-TL-PLUS-Q
<b>Input side</b>					
Absolute maximum DC input voltage ( $V_{max,abs}$ )	600 V				
Start-up DC input voltage ( $V_{start}$ )	200 V (adj. 120...350 V)				
Operating DC input voltage range ( $V_{d,min}...V_{d,max}$ )	0.7 x $V_{start}...580$ V (min 90 V)				
Rated DC input voltage ( $V_{dcr}$ )	360 V				
Rated DC input power ( $P_{dcr}$ )	3910 W	4250 W	4750 W	5150 W	6200 W
Number of independent MPPT	2				
Maximum DC input power for each MPPT ( $P_{MPPT,max}$ )	3000 W	3000 W	3000 W	3500 W	4000W (MPPT1), 3500W (MPPT2)
DC input voltage range with parallel configuration of MPPT at $P_{acr}$	130...530 V	130...530 V	150...530 V	170...480 V	200...480V
DC power limitation with parallel configuration of MPPT $P_{acr}$	Linear derating from Max to Null [530V ≤ $V_{MPPT}$ ≤ 580V]	Linear derating from Max to Null [530V ≤ $V_{MPPT}$ ≤ 580V]	Linear derating from Max to Null [530V ≤ $V_{MPPT}$ ≤ 580V]	Linear derating from Max to Null [480V ≤ $V_{MPPT}$ ≤ 580V]	Linear derating from Max to 500W [480V ≤ $V_{MPPT}$ ≤ 580V]
DC power limitation for each MPPT with independent configuration of MPPT at $P_{acr}$ , max unbalance example	3000 W [190 V ≤ $V_{MPPT}$ ≤ 530 V] the other channel: $P_{dcr}$ -3000 W [90 V ≤ $V_{MPPT}$ ≤ 530 V]	3000 W [190 V ≤ $V_{MPPT}$ ≤ 530 V] the other channel: $P_{dcr}$ -3000 W [90 V ≤ $V_{MPPT}$ ≤ 530 V]	3000 W [190 V ≤ $V_{MPPT}$ ≤ 530 V] the other channel: $P_{dcr}$ -3000 W [90 V ≤ $V_{MPPT}$ ≤ 530 V]	On MPPT 1: 3500 W [185 V ≤ $V_{MPPT}$ ≤ 480 V] On MPPT 2: $P_{dcr}$ -3500 W [145 V ≤ $V_{MPPT}$ ≤ 480 V] or 3500 W (305 V ≤ $V_{MPPT}$ ≤ 480 V) with no power on MPPT1	On MPPT1: 4000W (200V ≤ $V_{MPPT}$ ≤ 480) On MPPT2: $P_{dcr}$ -4000W (195V ≤ $V_{MPPT}$ ≤ 480) or 3500W (305V ≤ $V_{MPPT}$ ≤ 480) with no power on MPPT1
Maximum DC input current ( $I_{d,max}$ ) / for each MPPT ( $I_{MPPT,max}$ )	32.0/16.0 A	32.0/16.0 A	32.0/16.0 A	30.5/19-11.5 A (MPPT 1 - MPPT 2)	31.5 A / 20-11.5 A, (MPPT1-MPPT2)
Maximum input short circuit current for each MPPT	20.0 A	20.0 A	20.0 A	22.0 A	25.0 A
Number of DC input pairs for each MPPT	1			2 on channel 1: 1 on channel 2	
DC connection type <sup>1)</sup>	Quick Fit PV Connector				
<b>Input protection</b>					
Reverse polarity protection	Yes, from limited current source				
Input over voltage protection for each MPPT-varistor	Yes				
Photovoltaic array isolation control	According to local standard				
DC switch rating for each MPPT (version with DC switch)	25 A / 600 V				32 A / 600 V
<b>Output side</b>					
AC grid connection type	Single-phase				
Rated AC power ( $P_{acr}$ @ $\cos\phi=1$ )	3680 W	4000 W	4600 W	5000 W	6000 W
Maximum AC output power ( $P_{ac,max}$ @ $\cos\phi=1$ )	3680 W	4000 W <sup>2)</sup>	4600 W	5000 W	6000 W
Maximum apparent power ( $S_{max}$ )	3680 VA	4000 VA <sup>2)</sup>	4600 VA	5000 VA	6650 VA
Rated AC grid voltage ( $V_{ac,r}$ )	230 V				
AC voltage range <sup>3)</sup>	180...264 V				
Maximum AC output current ( $I_{ac,max}$ )	16 A	17.2 A	20.0 A	22.0 A	30.0 A
Contributory fault current	19.0 A	19.0 A	22.0 A	24.0 A	40.0 A
Rated output frequency ( $f_r$ ) <sup>4)</sup>	50/60 Hz				
Output frequency range ( $f_{min}...f_{max}$ ) <sup>4)</sup>	47...53/57...63 Hz				
Nominal power factor and adjustable range	> 0.995, adj. ± 0.1 - 1 (over/under excited)				> 0.995, adj. ± 0.8
Total current harmonic distortion	<3.5%				< 3%
AC connection type	Female connector from panel				Terminal Block
<b>Output protection</b>					
Anti-islanding protection	According to local standard				
Maximum external AC overcurrent protection	25.0 A	25.0 A	25.0 A	32.0 A	40.0 A
Output overvoltage protection - varistor	2 (L - N / L - PE)				

## Technical data and types

Type code	UNO-DM-3.6-TL-PLUS-Q	UNO-DM-4.0-TL-PLUS-Q	UNO-DM-4.6-TL-PLUS-Q	UNO-DM-5.0-TL-PLUS-Q	UNO-DM-6.0-TL-PLUS-Q
<b>Operating performance</b>					
Maximum efficiency ( $\eta_{max}$ )	97.0%	97.0%	97.0%	97.4%	97.4%
Weighted efficiency (EURO/CEC)	96.5% / -	96.5% / -	96.5% / -	97.0% / -	97.0% / -
Feed in power threshold	8 W				
Night consumption	<0.4 W				
<b>Embedded communication</b>					
Communication interface <sup>5)</sup>	Wireless				
Embedded communication protocol	ModBus TCP (SunSpec)				
Commissioning tool	Web User Interface, Aurora Manager Lite				
Monitoring	Plant Portfolio Manager, Plant Viewer, Plant Viewer for Mobile, Energy Viewer				
<b>Optional board UNO-DM-COM kit</b>					
Optional communication interface	RS485 (use with meter for dynamic feed-in control), Alarm/Load manager relay, Remote ON/OFF				
Optional communication protocol	ModBus RTU (SunSpec), Aurora Protocol				
<b>Optional board UNO-DM-PLUS Ethernet COM kit</b>					
Optional communication interface	Ethernet, RS485 (use with meter for dynamic feed-in control), Alarm/Load manager relay, Remote ON/OFF				
Optional communication protocol	ModBus TCP (SunSpec), ModBus RTU (SunSpec), Aurora Protocol				
<b>Environmental</b>					
Ambient temperature range	-25...+60°C / -13...140°F with derating above 50°C/122°F	-25...+60°C / -13...140°F with derating above 50°C/122°F	-25...+60°C / -13...140°F with derating above 40°C/104°F	-25...+60°C / -13...140°F with derating above 45°C/113°F	-25...+60°C / -13...140°F with derating above 45°C/113°F
Relative humidity	0...100 % condensing				
Maximum operating altitude	2000 m / 6560 ft (without derating)				
<b>Physical</b>					
Environmental protection rating	IP 65				
Cooling	Natural				
Dimension (H x W x D)	553 x 418 x 175 mm / 21.8" x 16.5" x 6.9"				
Weight	15 kg / 33 lbs				
Mounting system	Wall bracket				
<b>Safety</b>					
Isolation level	Transformerless				
Marking	CE	CE , RCM			CE (50 Hz only), RCM
Safety and EMC standard	IEC/EN 62109-1, IEC/EN 62109-2, EN 61000-6-1, EN 61000-6-2, EN 61000-6-3, EN 61000-6-4, EN 61000-3-11, EN 61000-3-12	IEC/EN 62109-1, IEC/EN 62109-2, AS/NZS 4777.2, EN 61000-6-1, EN 61000-6-2, EN 61000-6-3, EN 61000-6-4, EN 61000-3-11, EN 61000-3-12			EN 50178, IEC/EN 62109-1, IEC/EN 62109-2, AS/NZS 3100, EN 61000-6-1, EN 61000-6-3, EN 61000-3-11, EN 61000-3-12
Grid standard (check your sales channel for availability) <sup>6)</sup>	G98-1, G99-1	CEI 0-21, DIN V VDE V 0126-1-1, VDE-AR-N 4105, G83/2, G59/3, G98-1, G99-1, RD 413, ITC-BT-40, AS/NZS 4777.2, C10/11, IEC 61727, IEC 62116			CEI 0-21, DIN V VDE V 0126-1-1, ITC-BT-40, AS 4777, INMETRO Ordinances 357-2014
<b>Available products variants</b>					
Standard	UNO-DM-3.6-TL-PLUS-B-Q	UNO-DM-4.0-TL-PLUS-B-Q	UNO-DM-4.6-TL-PLUS-B-Q	UNO-DM-5.0-TL-PLUS-B-QU	UNO-DM-6.0-TL-PLUS-B-G-QU
With DC switch	UNO-DM-3.6-TL-PLUS-SB-Q	UNO-DM-4.0-TL-PLUS-SB-Q	UNO-DM-4.6-TL-PLUS-SB-Q	UNO-DM-5.0-TL-PLUS-SB-QU	UNO-DM-6.0-TL-PLUS-SB-G-QU

1) Refer to the document "String inverter – Product Manual appendix" available at [www.fimer.com](http://www.fimer.com) to know the brand and the model of the quick fit connector"

2) For UK G83/2 and G98-1 settings, maximum output current limited to 16 A

3) The AC voltage range may vary depending on specific country grid standard

4) The Frequency range may vary depending on specific country grid standard;  
CE is valid for 50Hz only

5) As per IEEE 802.11 b/g/n standard

6) Further grid standard will be added, please refer to FIMER's Solar page for further details

### Remarks:

- **Designed and manufactured in Italy**
- **Features not specifically listed in the present data sheet are not included in the product**



# Relax and unwind with FIMER You got 5 more years of protection to go

Thanks to FIMER's 10-year extended warranty program for the UNO-DM-PLUS-Q family across Europe, you can take an extra load off your mind and look forward to enjoying your PV system even more.

Your peace of mind is only three steps away:

- Connect to our website
- Register your UNO-DM-PLUS-Q inverter
- Protect your solar plant



**Finally, relax and unwind. Treat yourself to the best.**  
**Treat yourself to FIMER.**



# Prosumers pave path to energy self-reliance for sustainable living

An emerging generation of renewable energy users are producing and consuming their own power, as the vision of a zero-emissions future becomes mainstream.

A growing group of “prosumers” — renewable energy users who produce and consume their own power — are driving demand for solutions that support self-reliant living, cutting their own electricity bills while helping society mitigate climate change via reduced carbon emissions. But prosumers aren’t roughing it.

The availability of connected solutions, which can remotely manage energy usage, control heating or even launch a favorite playlist, means that self-reliant homes are rapidly becoming venues for more comfortable and convenient lifestyles.

It’s all part of the rise of the “clean energy economy,” where intelligent buildings equipped with photovoltaic (PV) cells and turnkey solar power storage solutions are enabling families and businesses to achieve energy self-sufficiency. For prosumers ready to turn their dreams of energy independence into reality, FIMER has combined the solar inverter with energy storage capability, in a modular system called REACT 2.

REACT 2 does dual duty to support up to 90 % energy self-sufficiency: the inverter portion of the system delivers AC for household power, and it also sends excess electricity to the unit’s lithium-ion battery, available with storage capacities from 4 kWh to 12 kWh (REACT2-BATT) or from 5 kWh to 15 kWh (REACT2-BATT-5.0) where it’s stored for later use. In real-world operation, excess electricity is typically produced by rooftop solar cells during peak hours of sunlight. It’s stored by the REACT 2 for use after dark, during the night, and early in the morning. The upshot is that prosumers are never without energy.

The security of “always on” power is one reason why the majority of prosumer don’t go entirely “off the grid”. Maintaining a connection back to the utility supports excess demand that can not be met by self-production, provides backup in the case of local equipment failure and enables prosumers to sell excess power back to the utility.

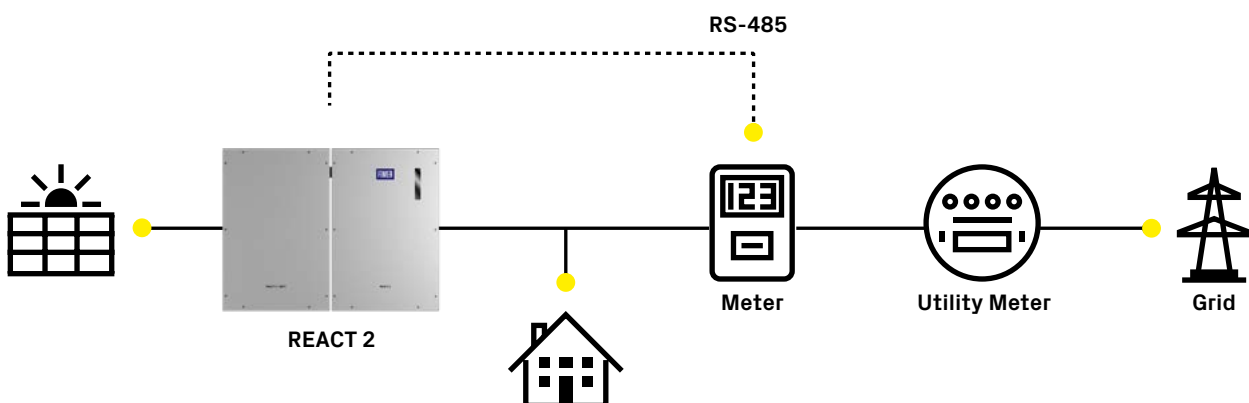

# FIMER PV + Storage

## REACT 2

### 3.6 to 5.0 kW

REACT 2 is FIMER's photovoltaic energy storage system, allowing to store excess energy and optimize the energy use in residential applications.

This line, available in power ratings of 3.6 and 5.0 kW, has one of the industry's highest energy efficiency rates, providing up to 10% more energy than lower voltage battery systems.

#### **For new and retrofit installations**

Thanks to the possibility of both AC and DC side connection, REACT 2 is the ideal solution for new systems or the retrofitting of existing ones, allowing homeowners to improve their energy self-consumption and save on their energy bills.

#### **Wide battery capacity**

Providing a totally flexible solution, REACT 2 offers a wide storage capacity, which can be expanded from 4 kWh to 12 kWh (REACT2-BATT) or from 5 kWh to 15 kWh (REACT2-BATT-5.0), depending on the number of batteries used, and can achieve up to 90 percent energy self-reliance. The addition of further battery units can take place anytime during the lifetime of the system.

#### **Design flexibility**

The different set-up configurations available allow maximum installation flexibility and optimization of available spaces. Quick and easy to install thanks to the simple plug and play

connection, both on inverter and battery side.

#### **Smart connectivity**

Future proof technology enables a full smart home experience with advanced communication features and load management capabilities.

The embedded data logger and direct transferring of data to a secure cloud platform allows customers to monitor and keep their system under control through the dedicated mobile app.

The advanced communication interfaces combined with a standard Modbus communication protocol, Sunspec compliant, allow the inverter to be easily integrated within any smart environment and with third party monitoring and control systems.

#### **Highlights**

- Li-Ion battery unit for energy storage (from 4 kWh to 12 kWh) or from 5 kWh to 15 kWh based on battery model choice)
- Industry leading energy efficiency
- Suitable for new and existing applications
- Battery units can be upgraded anytime during lifetime of system
- Flexible and modular design, optimizes installation space
- Simple and safe installation with plug and play connection
- System monitoring through dedicated mobile app
- Modbus TCP/RTU Sunspec compliant
- Full integration with FIMER FLEXA AC Wallbox Inverter Net
- FIMER PowerGain yield optimization
- Energy community ready



FIMER REACT 2 block diagram

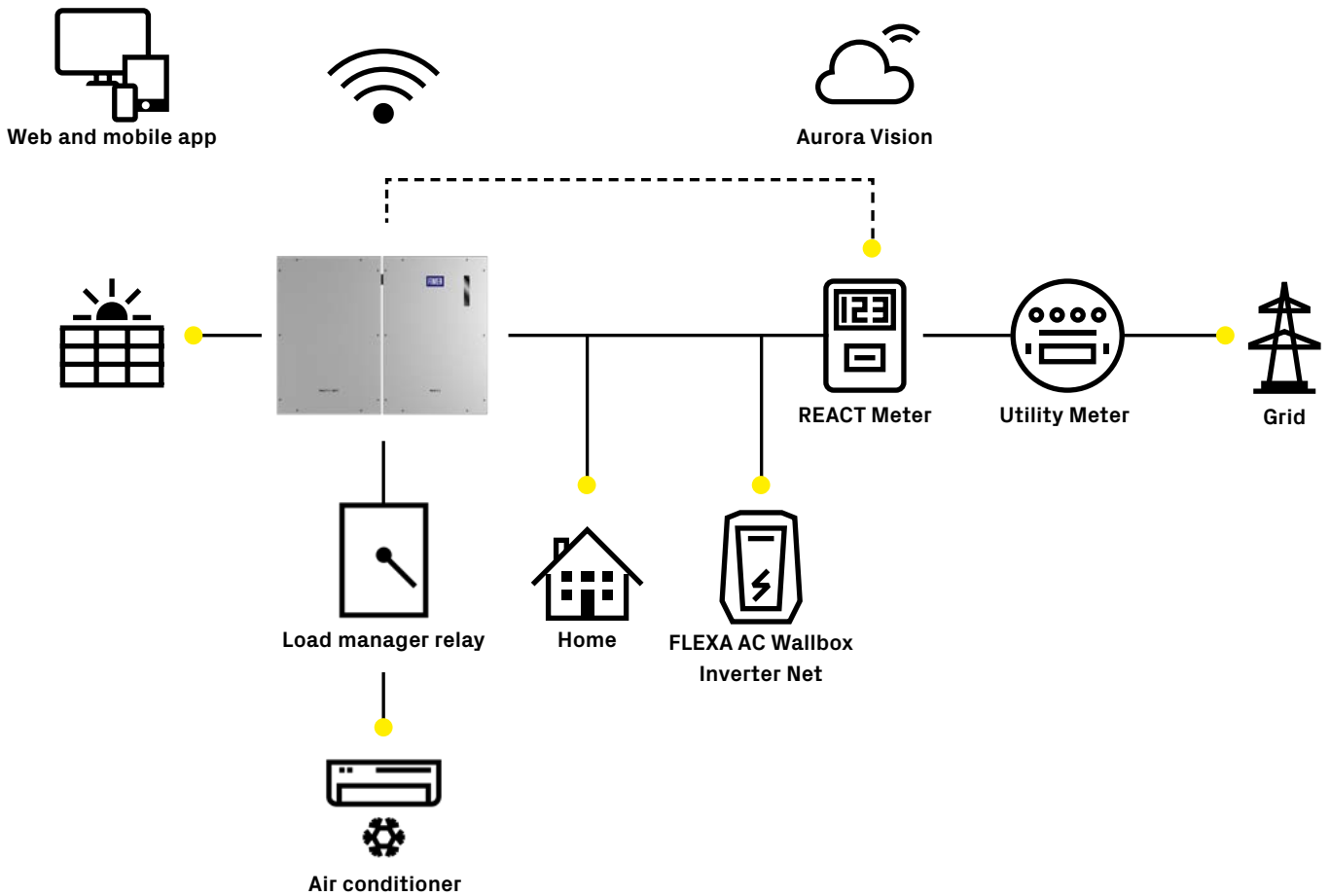

## Technical data and types

Inverter	REACT2-UNO-3.6-TL	REACT2-UNO-5.0-TL
<b>Input side</b>		
Absolute maximum DC input voltage ( $V_{max,abs}$ )		575 V
Start-up DC input voltage ( $V_{start}$ )		200 V (adj. 120...350 V)
Operating DC input voltage range ( $V_{dcmin}...V_{dcmax}$ )		$0.7 \times V_{start}...575$ V (min 90 V)
Rated DC input voltage ( $V_{dcr}$ )		390 V
Rated DC input power ( $P_{dcr}$ )	5000 W	6000 W
Suggested maximum DC input power	6666 W	8000 W
Number of independent MPPT		2
Maximum DC input power for each MPPT ( $P_{MPPT max}$ )	2500 W Linear derating [ $480 V \leq V_{MPPT} \leq 575 V$ ]	3000 W Linear derating [ $480 V \leq V_{MPPT} \leq 575 V$ ]
DC input voltage range with parallel configuration of MPPT at $P_{dcr}$ , not operative battery	160 V...480 V	195 V...480 V
Maximum DC input current ( $I_{dc max}$ ) / for each MPPT ( $I_{MPPT max}$ )	24 A / 12 A	27 A / 13.5 A
Maximum input short circuit current for each MPPT		15.0 A
Number of DC inputs pairs for each MPPT		2
DC connection type		PV quick fit connector <sup>3)</sup>
<b>Input protection</b>		
Reverse polarity protection		Yes, from limited current source
Input over voltage protection for each MPPT - varistor		Yes
Photovoltaic array isolation control		According to local standard
DC switch rating for each MPPT		25 A / 575 V
<b>Battery port</b>		
Operating DC voltage range		170-575 V
N° of battery units	1, 2, 3	1, 2, 3
Charge power	1.6 kW, 3.2 kW, 4.8 kW (REACT2-BATT) 2 kW, 4 kW, 5 kW (REACT2-BATT-5.0)	1.6 kW, 3.2 kW, 4.8 kW (REACT2-BATT) 2 kW, 4 kW, 6 kW (REACT2-BATT-5.0)
Discharge power	2 kW, 3.6 kW, 3.6 kW (REACT2-BATT) 2.5 kW, 3.6 kW, 3.6 kW (REACT2-BATT-5.0)	2 kW, 4 kW, 5 kW (REACT2-BATT) 2.5 kW, 5 kW, 5 kW (REACT2-BATT-5.0)
<b>Grid connected output side</b>		
AC Grid connection type		Single-phase
Rated AC power ( $P_{acr} @ \cos\phi=1$ )	3600 W	5000 W <sup>2)</sup>
Maximum AC output power ( $P_{acmax} @ \cos\phi=1$ )	3600 W	5000 W <sup>2)</sup>
Maximum apparent power ( $S_{max}$ )	3600 VA	5000 VA <sup>2)</sup>
Rated AC grid voltage ( $V_{acr}$ )		230 V
AC voltage range		180...264 V <sup>3)</sup>
Maximum AC output current ( $I_{ac max}$ )	16 A	22 A
Contributory fault current	16 A	22 A
Rated output frequency ( $f_r$ )		50 Hz / 60 Hz
Output frequency range ( $f_{min}...f_{max}$ )		45...55 Hz / 55...65 Hz <sup>4)</sup>
Nominal power factor and adjustable range		> 0.995, adj. $\pm 0.1 - 1$ (over/under excited)
Total current harmonic distortion		< 3%
AC connection type		AC circular connector
<b>Grid connected output protection</b>		
Anti-islanding protection		According to local standard
Maximum external AC overcurrent protection	20 A	25 A
Output overvoltage protection - varistor		2 (L - N / L - PE)
<b>Backup output side</b>		
AC grid connection type		Single-phase
Maximum apparent power ( $S_{max}$ )		3000 VA
Rated AC grid Voltage ( $V_{acr}$ )		230 V
AC Voltage range		180...264 V <sup>4)</sup>
Maximum AC output current ( $I_{ac max}$ )		13 A
Rated output frequency ( $f_r$ )		50 Hz / 60 Hz
Output frequency range ( $f_{min}...f_{max}$ )		45...55 Hz / 55...65 Hz <sup>5)</sup>
AC connection type		Screw terminal block
<b>Backup output protection</b>		
Maximum external AC overcurrent protection		16 A
Output overvoltage protection - varistor		2 (L-N/L-PE)
<b>Embedded communication</b>		
Embedded physical interface		Wi-Fi <sup>®</sup> , 2 x Ethernet, RS485
Embedded communication protocols		Modbus TCP (SunSpec), Modbus RTU (SunSpec), ABB-free@home <sup>®</sup>
Datalogger data retention		30 days

## Technical data and types

Inverter	REACT2-UNO-3.6-TL	REACT2-UNO-5.0-TL
Remote monitoring		Mobile app
Local monitoring		Web server user interface
<b>Environmental</b>		
Ambient temperature range	-20...+55°C with derating above 50°C	-20...+55°C with derating above 45°C
Relative humidity		4...100 % condensing
Acoustic noise emission level		< 50 dB (A) @ 1 m
Maximum operating altitude without derating		2000 m
<b>Physical</b>		
Environmental protection rating		IP65
Cooling		Natural
Dimension (H x W x D)		740 mm x 490 mm x 229 mm
Weight		< 22 kg
Mounting system		Wall bracket
<b>Safety</b>		
Isolation level		Transformerless
Marking		CE (50 Hz only)
Safety and EMC standard	IEC/EN 62109-1, IEC/EN 62109-2, IEC 62477-1, EN 61000-6-2, EN 61000-6-3, EN 61000-3-2, EN 61000-3-3, EN61000-3-11, EN61000-3-12	
Grid standard (check your sales channel for availability)	CEI 0-21, DIN V VDE V 0126-1-1, VDE-AR-N 4105, G83/2, G59/3, RD 413, AS/NZS 4777.2, C10/11, IEC 61727, IEC 62116	
<b>Other features</b>		
Load manager		Yes, with two integrated relays
AC backup output, off grid		Yes
Battery charge from AC		Yes, it can be enabled
AC-coupled feature		Yes, settable during commissioning

## Technical data and types

Battery unit	REACT2-BATT	REACT2-BATT-5.0
Battery type		Li-Ion
Total energy	4 kWh	5 kWh
Operating DC voltage range		170-575 V
Absolute maximum DC voltage		575 V
Module voltage		200 V
Deep of discharge (DoD)	95%	90%
Charge power	1.6 kW	2 kW
Discharge power	2 kW	2.5 kW
<b>Environmental</b>		
Environmental protection rating	IP 54 (suggested indoor installation for preserving battery life time)	
Ambient temperature range	-20...+55°C (power derating occurs out of suggested ambient temperature range)	
Suggested ambient temperature		+0 to +40 °C
Relative humidity		4...100 % condensing
<b>Physical</b>		
Cooling		Natural
Dimension (H x W x D)		740 mm x 490 mm x 229 mm
Weight		< 50 kg
Mounting system		Wall bracket
<b>Safety</b>		
Marking		CE
Safety		IEC 62619, UN38.3, UN3480
<b>Compatible meters<sup>6)</sup></b>		
REACT-MTR-1PH		Single-phase, 20 A
ABB B21		Single-phase, 65 A
ABB B23		Three-phase, 65 A
ABB B24		Three-phase, External CT (opt.)
ABB A43		Three-phase, 80 A
ABB A44		Three-phase, External CT (opt.)

1) Refer to the document "String inverter – Product Manual appendix" available at [www.fimer.com/solarinverters](http://www.fimer.com/solarinverters) to know the brand and the model of the quick fit connector"

2) For VDE-AR-N 4105 setting, maximum active power of 4600 W and maximum apparent power of 4600 VA

3) The AC voltage range may vary depending on specific country grid standard

4) The Frequency range may vary depending on specific country grid standard

5) As per IEEE 802.11 b/g/n standard

6) Refer to the document "Meters supported by FIMER string inverters and the VSN700-05 Data Logger", available at [www.fimer.com](http://www.fimer.com), to know the complete compatible meter list

### Remarks:

- **Designed and manufactured in Italy**
- **Features not specifically listed in the present data sheet are not included in the product**

# FIMER string inverters

## TRIO-5.8/7.5/8.5-TL-OUTD

### 5.8 to 8.5 kW

The all-in-one residential three-phase TRIO-5.8, 7.5 and 8.5 kW inverters deliver performance, ease of use and installation, monitoring and control. With their 98% peak efficiency and wide input voltage range, the residential TRIO inverter means flexible installations and powerful output.

#### Commercial grade engineering at residential scale

The topology of the larger, commercial TRIO inverters has been redesigned to ensure that the TRIO-5.8/7.5/8.5 models also enjoy high conversion efficiency across a wide range of input voltages.

Optional integrated dataloggers and smart grid functionality, remote firmware updating and elegantly simple sliding front covers make these all-in-one devices easy to install and maintain. In short, they are commercial grade engineering at residential scale.

#### Inverters packed with powerful features

The double maximum power point tracker (MPPT) gives maximum installation flexibility for an optimal energy production (TRIO-7.5/8.5 models). This line of inverters can integrate power control, monitoring functionalities and environmental sensor inputs, without requiring external components.

TCP/IP connectivity can be also added by plugging in an optional expansion board (Ethernet or Wi-Fi) for providing data logging functionality for monitoring the main parameters of the plant as well as advanced O&M operations both locally (with the integrated webserver) and remotely (with the AV Plant Portfolio Manager portal), via a LAN connection.

The outer cover with its natural cooling mechanism qualifies at IP65 environmental protection level for external use. It provides maximum reliability and ease of installation, with a sliding front panel giving access to the connection and configuration area without requiring the complete removal of the cover.

#### Highlights

- Two independent MPPT channels for TRIO-7.5/8.5 allow optimal energy harvesting from two sub-arrays oriented in different directions (one MPPT channel for TRIO-5.8)
- Flat efficiency curves ensure high efficiency at all output levels enabling consistent and stable performance across the entire input voltage and output power range
- Wide input voltage range
- Remote inverter upgrade
- Reactive power management
- Natural convection cooling for maximum reliability
- Outdoor enclosure for unrestricted use under any environmental conditions (IP65)
- Sliding cover for the easiest installation and maintenance
- Data logger and smart grid functionalities integrated on expansion cards:
  - PMU expansion card option, with external sensor inputs for monitoring environmental conditions and additional RS-485 for Modbus protocol
  - Ethernet or VSN300 Wifi Logger card (optional) with integrated web server
  - Availability of auxiliary DC output voltage (24 V, 100 mA)
  - FIMER PowerGain yield optimization
- Energy community ready



FIMER TRIO-5.8/7.5/8.5-TL-OUTD block diagram

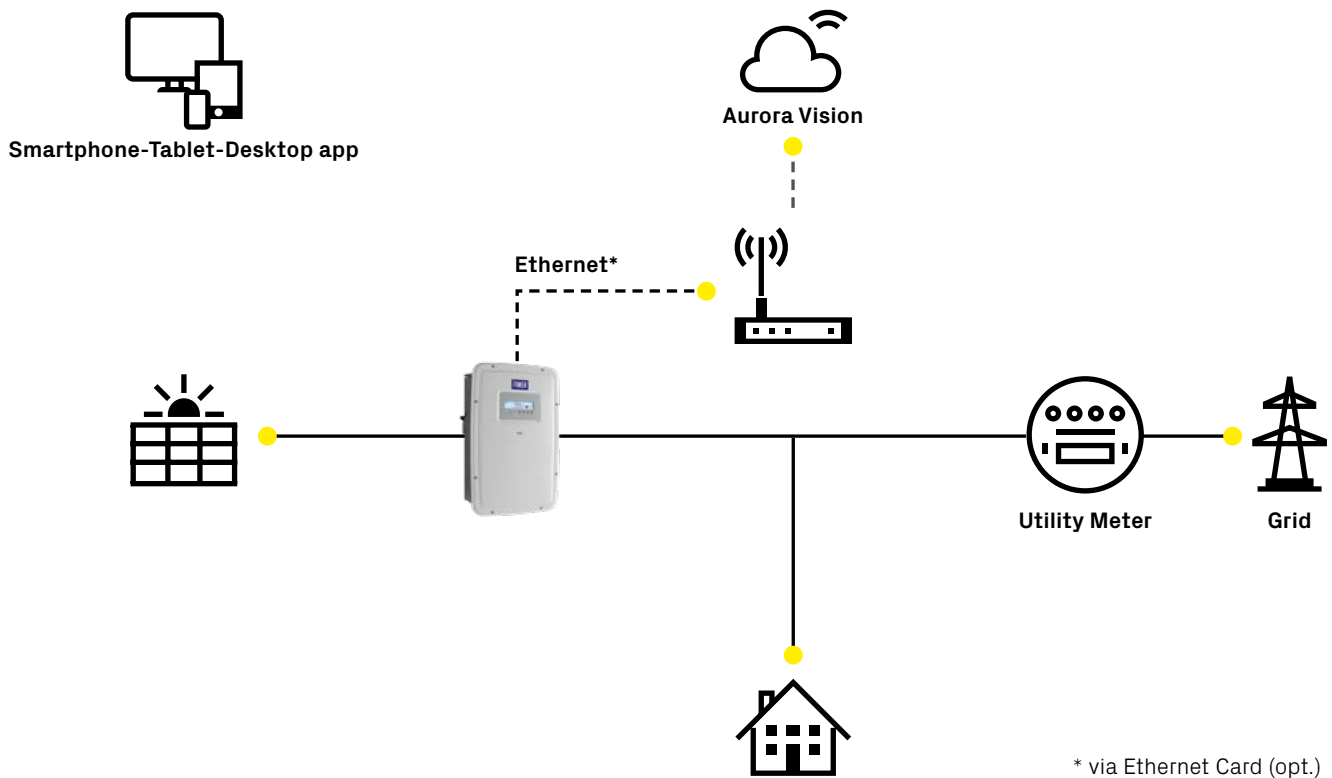

## Technical data and types

Type code	TRIO-5.8-TL-OUTD	TRIO-7.5-TL-OUTD	TRIO-8.5-TL-OUTD
<b>Input side</b>			
Absolute maximum DC input voltage ( $V_{max,abs}$ )		1000 V	
Start-up DC input voltage ( $V_{start}$ )		350 V (adj. 200...500 V)	
Operating DC input voltage range ( $V_{dcmin}...V_{dcmax}$ )		0.7 x $V_{start}...950$ V (min 200 V)	
Rated DC input voltage ( $V_{dcr}$ )		620 V	
Rated DC input power ( $P_{dcr}$ )	5950 W	7650 W	8700 W
Number of independent MPPT	1	2	2
Maximum DC input power for each MPPT ( $P_{MPPTmax}$ )	6050 W Linear derating from max to null [800 V ≤ $V_{MPPT}$ ≤ 950 V]	4800 W	4800 W
MPPT input DC voltage range ( $V_{MPPTmin}...V_{MPPTmax}$ ) at $P_{acr}$	320...800 V	-	-
DC input voltage range with parallel configuration of MPPT at $P_{acr}$	-	320...800 V	320...800 V
DC power limitation with parallel configuration of MPPT	-	Linear derating from max to null [800 V ≤ $V_{MPPT}$ ≤ 950 V]	
DC power limitation for each MPPT with independent configuration of MPPT at $P_{acr}$ , max unbalance example	-	4800 W [320 V ≤ $V_{MPPT}$ ≤ 800 V] the other channel: $P_{dcr}$ -4800 W [215 V ≤ $V_{MPPT}$ ≤ 800 V]	4800 W [320 V ≤ $V_{MPPT}$ ≤ 800 V] the other channel: $P_{dcr}$ -4800 W [290 V ≤ $V_{MPPT}$ ≤ 800 V]
Maximum DC input current ( $I_{dcmax}$ ) / for each MPPT ( $I_{MPPTmax}$ )	18.9 A	30.0 A / 15.0 A	30.0 A / 15.0 A
Maximum input short circuit current for each MPPT	24.0 A	20.0 A	20.0 A
Number of DC input pairs for each MPPT		2 (-S version)	
DC connection type	PV quick fit connector <sup>1)</sup> on -S version / Screw terminal block on standard version		
<b>Input protection</b>			
Reverse polarity protection		Yes, from limited current source	
Input over voltage protection for each MPPT - varistor		Yes, 4	
Photovoltaic array isolation control		According to local standard	
DC switch rating for each MPPT (version with DC switch)		16 A / 1000 V, 25 A / 800 V	
<b>Output side</b>			
AC grid connection type		Three-phase 3W+PE or 4W+PE	
Rated AC power ( $P_{acr}@cos\phi=1$ )	5800 W	7500 W	8500 W
Maximum apparent power ( $S_{max}$ )	5800 VA	7500 VA	8500 VA
Rated AC grid voltage ( $V_{acr}$ )		400 V	
AC voltage range		320...480 V <sup>2)</sup>	
Maximum AC output current ( $I_{ac,max}$ )	10.0 A	12.5 A	14.5 A
Contributory fault current	12.0 A	14.5 A	16.5 A
Rated output frequency ( $f_r$ )		50 Hz / 60 Hz	
Output frequency range ( $f_{min}...f_{max}$ )		47...53 Hz / 57...63 Hz <sup>3)</sup>	
Nominal power factor and adjustable range	> 0.995, adj. ± 0.9 with $P_{acr}$ =5.22 kW, ± 0.8 with max 5.8 kVA	> 0.995, adj. ± 0.9 with $P_{acr}$ =6.75 kW, ± 0.8 with max 7.5 kVA	> 0.995, adj. ± 0.9 with $P_{acr}$ =7.65 kW, ± 0.8 with max 8.5 kVA
Total current harmonic distortion		< 2%	
AC connection type		Screw terminal block, cable gland M32	
<b>Output protection</b>			
Anti-islanding protection		According to local standard	
Maximum external AC overcurrent protection	16.0 A	16.0 A	20.0 A
Output overvoltage protection - varistor		4 plus gas arrester	
<b>Operating performance</b>			
Maximum efficiency ( $\eta_{max}$ )		98.0%	
Weighted efficiency (EURO/CEC)	97.4% / -	97.5% / -	97.5% / -
Feed in power threshold	32 W	36 W	36 W
Night consumption		< 3 W	
<b>Communication</b>			
Wired local monitoring	Ethernet card with webserver (opt.), PVI-USB-RS232_485 (opt.)		
Remote monitoring	Ethernet card (opt.), VSN300 Wifi Logger Card (opt.), VSN700 Data Logger (opt.)		
Wireless local monitoring	VSN300 Wifi Logger Card (opt.)		
User interface	Graphic display		



## Technical data and types

Type code	TRIO-5.8-TL-OUTD	TRIO-7.5-TL-OUTD	TRIO-8.5-TL-OUTD
<b>Environmental</b>			
Ambient temperature range	-25...+60°C / -13...140°F with derating above 50°C/122°F		
Relative humidity	0...100% condensing		
Sound pressure level, typical	50 dBA @ 1 m		
Maximum operating altitude without derating	2000 m / 6560 ft		
<b>Physical</b>			
Environmental protection rating	IP65		
Cooling	Natural		
Dimension (H x W x D)	641mm x 429 mm x 220 mm/ 25.2" x 16.9" x 8.7" (855 mm x 429 mm x 237 mm/ 33.7" x 16.9" x 9.3" with open front cover)		
Weight	25.0 kg / 55.1 lbs	28.0 kg / 61.7 lbs	28.0 kg / 61.7 lbs
Mounting system	Wall bracket		
<b>Safety</b>			
Isolation level	Transformerless		
Marking	CE (50 Hz only), RCM		
Safety and EMC standard	EN 62109-1, EN 62109-2, AS/NZS3100, EN 61000-6-2, EN 61000-6-3, EN 61000-3-2, EN 61000-3-3		
Grid standard (check your sales channel for availability)	CEI 0-21, CEI 0-16, DIN V VDE V 0126-1-1, VDE-AR-N 4105, G83/2, G59/3, RD 1699, RD 413, NRS-097-2-1, AS 4777, IEC 61727, IEC 62116, VFR 2014, EN 50549-1, EN 50549-2		
<b>Available products variants</b>			
Standard	TRIO-5.8-TL-OUTD-400	TRIO-7.5-TL-OUTD-400	TRIO-8.5-TL-OUTD-400
With DC switch	TRIO-5.8-TL-OUTD-S-400	TRIO-7.5-TL-OUTD-S-400	TRIO-8.5-TL-OUTD-S-400

1) Please refer to the document "String inverters – Product manual appendix" available at [www.fimer.com](http://www.fimer.com) for information on the quick-fit connector brand and model used in the inverter

2) The AC voltage range may vary depending on specific country grid standard)

3) The Frequency range may vary depending on specific country grid standard

#### Remarks:

- **Designed and manufactured in Italy**
- **Features not specifically listed in the present data sheet are not included in the product**



# Commercial and Industrial solutions

You can count on our flexible solutions whatever the scale and design of your project.

FIMER offers the broadest portfolio of commercial string inverters on the market, which includes a powerful line of three-phase string inverters for photovoltaic (PV) systems installed in commercial and industrial buildings.

Thanks to their modularity and flexibility, our commercial and industrial inverters are the ideal solution for a simplified system planning and design. The wide range of power ratings along with the possibility to install in either vertical or horizontal position make them the best choice for any rooftop solution.

Designed to optimize the total cost of ownership in PV projects, our inverters guarantee high total efficiency and reliability. The high power density and reduced installation and maintenance efforts enhance overall cost efficiency.

The solutions are complemented by a series of cloud based advanced communication services which simplify the integration in smart environments.



Power block size (kW)

# FIMER string inverters

## PVS-10/33-TL

### 10 to 33 kW

The PVS-10/33-TL is the new FIMER three-phase string inverter solution, ideal for the optimization of installation and operational costs in commercial and industrial PV plants.

This new PVS string inverter family, with power ratings of up to 33 kW, has been designed with the objective to maximize the ROI in commercial and industrial applications such as rooftop plants, carports and trackers.

#### **Ease of installation and maintenance**

The compact design of the product allows savings on installation costs. The installation is quick and easy, without the need to open the front cover.

Moreover, being fuse-free, this inverter guarantees further savings on maintenance costs and time, reducing on site interventions to a minimum.

#### **Maximum flexibility and integration**

The input voltage range and all DC-side specs as a whole allow for the greatest plant design flexibility within both new and existing installations.

This new inverter family guarantees maximum integration with the latest PV technologies, including bifacial modules.

#### **Advanced communication**

Fast commissioning thanks to the Solar Inverters installer app which enables a quick multi-inverter installation, saving up to 70% of commissioning time.

The single string current monitoring allows to keep the status of the PV generator under control and to detect potential faults in real time.

The built-in FIMER Export Limitation solution allows to comply with any power export constraints established by utilities, without any additional device to be installed.

#### **Integrated PID recovery function**

Inverters equipped with PID (Potential Induced Degradation) recovery function are able to restore the optimal conditions of the PV module in order to prevent performance losses which could be caused by the PID during standard operation. Such functionality allows to maintain the highest level of performance and to maximize the working life of the plant, hence, optimizing the return on investment.

#### **Integrated Arc Fault Circuit Interrupter**

The Integrated Arc Fault Circuit Interrupter allows to recognize and immediately interrupt the electric arcs which may occur on the PV system. Thanks to such functionality the inverter is able to offer a reliable fire prevention mechanism wherever required for roof mounted installations.

#### **RSD compatibility**

PVS-10/33 is tested for operation in PV systems equipped with Rapid Shutdown systems (RSD) and/or with I-V optimizers installed at module level (contact FIMER for a complete list of compatible systems).

#### **Highlights**

- Double Ethernet ports + Wi-Fi
- Communication active during the night
- High DC/AC power oversizing capability
- Compact inverter suitable for vertical and horizontal installation
- Fuse-free design
- Installation on new and existing plants
- Maximum string voltage 1100 Vdc
- High-current PV module support (PVS-20/30/33 only)
- PID recovery function (optional)
- Commissioning through the Solar Inverters installer app
- Remote monitoring and firmware upgrade via Aurora Vision cloud platform (embedded data-logger)
- Integrated Export Limitation function
- Single string current monitoring
- Arc fault circuit interrupter (optional)
- FIMER PowerGain yield optimization
- Energy community ready



FIMER PVS-10/12.5/15/20/30/33-TL block diagram

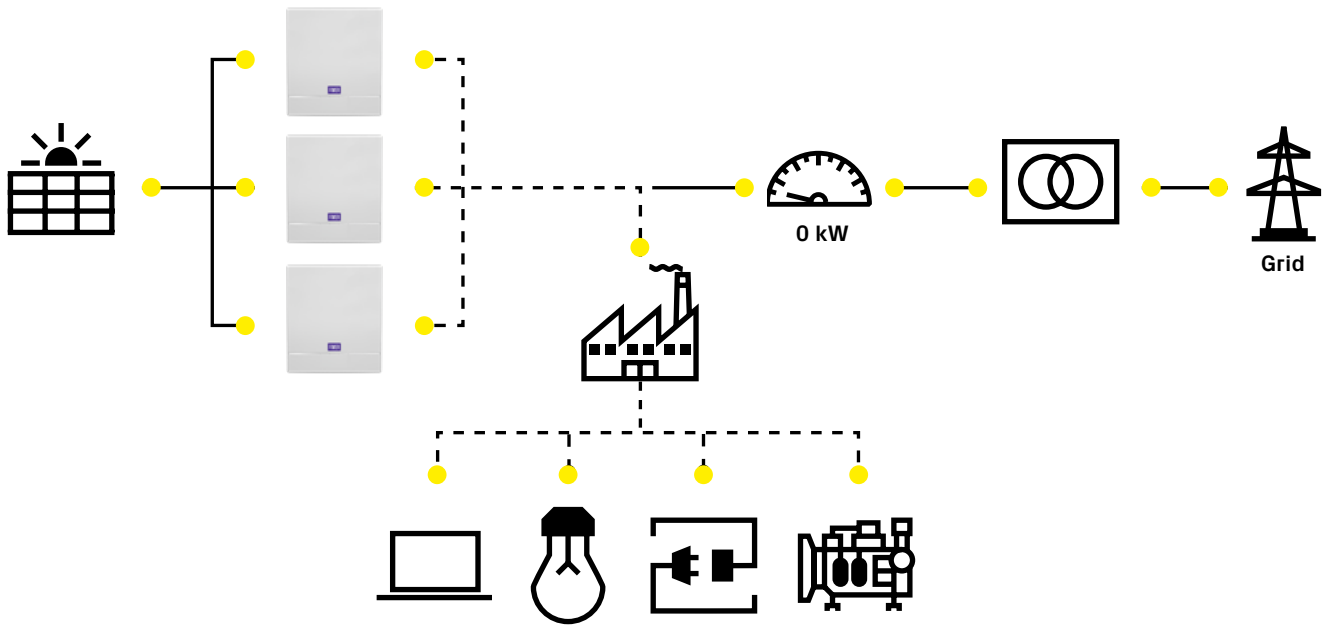

## Technical data and types

Type code	PVS-10-TL	PVS-12.5-TL	PVS-15-TL
<b>Input side</b>			
Absolute maximum DC input voltage ( $V_{max,abs}$ )		1100 V	
Start-up DC input voltage ( $V_{start}$ )		250...500V (default 360V)	
Operating DC input voltage range ( $V_{dmin}...V_{dmax}$ )		200-1000 V	
Rated DC input voltage ( $V_{dcr}$ )		620V	
Rated DC input power ( $P_{dcr}$ )	10200 W	12760 W	15300 W
Number of independent MPPT		2	
Maximum photovoltaic power recommended ( $P_{PV,max}$ )	14500 Wp	18125 Wp	21750 Wp
Maximum DC input power for each MPPT ( $P_{MPPT,max}$ )	7800W	8300W	10000W
MPPT input DC voltage range ( $V_{MPPTmin} ... V_{MPPTmax}$ ) a $P_{dcr}$		460-850V	
Maximum DC input current ( $I_{dcr,max}$ ) for each MPPT	2x17A	2x18A	2x22A
Maximum input short circuit current for each MPPT		30 A	
Number of DC input pairs for each MPPT		2	
DC connection type		PV quick fit connector	
<b>Input protection</b>			
Revers polarity protection		Yes, from limited current source	
Input over voltage protection for each MPPT		SPD Type II / Type I+II (optional)	
Isolation control		According to local standard	
<b>Output side</b>			
AC grid connection type		Three-phase (3W+PE or 3W+N+PE)	
Earthing system	TN-S, TN-C, TN-CS, TT	TN-S, TN-C, TN-CS, TT	TN-S, TN-C, TN-CS, TT
Rated AC power ( $P_{acr} @ \cos\phi=1$ )	10000 W	12500 W	15000 W
Maximum AC output power ( $P_{ac,max} @ \cos =1$ )	10000 W	12500 W	15000 W
Maximum apparent power ( $S_{max}$ )	10000 VA	12500 VA	15000 VA
Maximum reactive power ( $Q_{max}$ )	6000 VAR	7500 VAR	9000 VAR
Nominal power factor and adjustable range		> 0.995; 0.8...1 inductive/capacitive	
Rated AC output voltage ( $V_{acr}$ )		380V, 400V <sup>1)</sup>	
Maximum AC output current ( $I_{ac,max}$ )	16 A	20 A	23 A
Rated output frequency ( $f_r$ )		50 Hz / 60 Hz	
Output frequency range ( $f_{min}...f_{max}$ )		47...53 Hz / 57...63 Hz <sup>2)</sup>	
Total current harmonic distortion		<3%	
Maximum AC cable		16 mm <sup>2</sup> copper	
AC connection type		AC quick fit connector	
<b>Output protection</b>			
Anti-islanding protection		According to local standard	
Maximum external AC overcurrent protection	25 A	32 A	32 A
Output overvoltage protection		SPD Type II	
<b>Operating performance</b>			
Maximum efficiency ( $\eta_{max}$ )	98,4%	98,5%	98,5%
Weighted efficiency (EURO)	98,1%	98,2%	98,2%
<b>Communication</b>			
Embedded communication interfaces		Double Ethernet port, WLAN, RS485 port	
Communication protocol		Modbus TCP Sunspec, Modbus RTU Sunspec	
User interface		LEDs, Web User Interface, Installer APP, Display (optional)	
Cloud services		Aurora Vision® Plant Management Platform, Rest API	
Advanced features		Embedded export limitation control (in combination with external meter), 24h self-consumption monitoring	

## Technical data and types

Type code	PVS-10-TL	PVS-12.5-TL	PVS-15-TL
<b>Environmental</b>			
Ambient temperature range	-25...+60°C (-13...140 °F) with derating above 45 °C (113 °F)		
Relative humidity	4%... 100% with condensation		
Maximum operating altitude	4000 m (13123 ft) with derating above 2000 m (6561 ft)		
<b>Physical</b>			
Inverter type	Grid connected, double stage, transformerless		
Environmental protection rating	IP65		
Environmental classification	4K26 (IEC 60721-3-4)		
Cooling	Natural cooling		
Dimension (H x W x D)	568,2 x 473,6 x 207		
Weight	29,6 Kg		
Mounting system	Mounting bracket		
<b>Safety</b>			
Marking	CE, RCM		
Safety and EMC standards	IEC/EN 62109-1, IEC/EN 62109-2, EN 61000-6-1, EN 61000-6-2, EN 61000-3-11, EN 61000-3-12 EN 62311, EN 301 489-1, EN 301 489-17, EN 300 328		
Certificates and compliance (check your sales channel for availability)	IEC 61683, EN 50530, IEC 62116, IEC 61727, AS/NZS 4777.2, VDE-AR-N 4105, VDE-AR-N 4110, VDE V 0124-100, DIN VDE V 0126-1-1, VFR 2019, UTE C15-712-1, CEI 0-21, CEI 0-16, PEA, MEA, EN 50438, EN 50549-1/-2, DRRG (DUBAI), CLC/TS 50549-1/-2, G98, G99, Synergrid C10/11, RD 413, RD 1565, RD244, P.O. 12.3, NTS 631, UNE 206006 IN (ITC-BT-40), PPDS-priloha, Denmark Type A/B, IRR-DCC-MV, ABNT NBR 16149, ABNT NBR 16150, NRS 097-2-1, SII, ISO/IEC Guide 67, Netherlands Type A, EIFS Type A, Ireland		
<b>Available product versions</b>			
Inverter equipped with SPD Type 2 on the DC and AC side	PVS-10-TL-SX	PVS-12.5-TL-SX	PVS-15-TL-SX
Inverter equipped with SPD Type 1+2 on the DC side and Type 2 on the AC side	PVS-10-TL-SY	PVS-12.5-TL-SY	PVS-15-TL-SY
<b>Available ordering options</b>			
PID recovery	Only for SX version	Only for SX version	Only for SX version
AFCI (Arc Fault Circuit Interrupter)	Only for SX version	Only for SX version	Only for SX version
Display	Only for SX version	Only for SX version	Only for SX version

1) The output voltage range may vary depending on specific country grid standards  
2) The output frequency range may vary depending on specific country grid standards

### Remarks:

- **Designed and manufactured in Italy**
- **Features not specifically listed in the present data sheet are not included in the product**

## Technical data and types

Type code	PVS-20-TL (2MPPT)	PVS-20-TL (4MPPT)	PVS-30-TL	PVS-33-TL
<b>Input side</b>				
Absolute maximum DC input voltage ( $V_{max,abs}$ )	1100V			
Start-up DC input voltage ( $V_{start}$ )	250...500V (default 430V)			
Operating DC input voltage range ( $V_{dmin}...V_{dmax}$ )	200-1000 V			
Rated DC input voltage ( $V_{dcr}$ )	620V			
Rated DC input power ( $P_{dcr}$ )	20500 W	20500 W	30600 W	33700 W
Maximum photovoltaic power recommended ( $P_{pv,max}$ )	34000 Wp	34000 Wp	44000 Wp	48000 Wp
Number of independent MPPT	2	4	4	4
Maximum DC input current ( $I_{dmax}$ ) for each MPPT	2x26A	2x26A + 2x22A	2x26A + 2x22A	2x26A + 2x22A
Maximum DC input power for each MPPT ( $P_{MPPT,max}$ )	2x12000W	2x12000W + 2x10000W	2x12000W + 2x10000W	2x12000W + 2x10000W
MPPT input DC voltage range ( $V_{MPPTmin} ... V_{MPPTmax}$ ) at $P_{acr}$	460-850V			
Maximum input short circuit current for each MPPT	40A <sup>1)</sup>			
Number of DC inputs pairs for each MPPT	2			
DC connection type	PV quick fit connector			
<b>Input protection</b>				
Reverse polarity protection	Yes			
Input over voltage protection for each MPPT	SPD Type II / Type I+II (optional)			
Isolation control	Yes, according local regulation			
<b>Output side</b>				
AC grid connection type	Three-phase (3W+PE or 3W+N+PE)			
Earthing system	TN-S, TN-C, TN-CS, TT	TN-S, TN-C, TN-CS, TT	TN-S, TN-C, TN-CS, TT	TN-S, TN-C, TN-CS, TT, IT <sup>2)</sup>
Rated AC power ( $P_{acr} @ \cos \phi = 1$ )	20000 W	20000 W	30000 W	33000 W
Maximum AC output power ( $P_{ac,max} @ \cos \phi = 1$ )	22000 W up to 30°C <sup>3)</sup>	22000 W up to 30°C <sup>3)</sup>	33000 W up to 30°C <sup>5)</sup>	36300 W up to 30°C <sup>3)</sup>
Maximum apparent power ( $S_{max}$ )	22000 VA up to 30°C <sup>4)</sup>	22000 VA up to 30°C <sup>4)</sup>	33000 VA up to 30°C <sup>6)</sup>	36300 VA up to 30°C <sup>4)</sup>
Maximum reactive power ( $Q_{max}$ )	20000 VAR	20000 VAR	30000 VAR	33000 VAR
Nominal power factor and adjustable range	> 0.995; 0...1 inductive/capacitive			
Rated AC grid voltage ( $V_{ac,r}$ )	380V, 400V			
Maximum AC output current ( $I_{ac,max}$ )	33,4 A	33,4 A	50,1 A	55,1 A
Rated output frequency ( $f_r$ )	50 Hz / 60 Hz			
Output frequency range ( $f_{min}...f_{max}$ )	47...53 Hz / 57...63 Hz			
Total current harmonic distortion	<3%			
Maximum AC cable	35 mm <sup>2</sup> copper/aluminum			
AC connection type	Detachable Terminal Block			
<b>Output protection</b>				
Anti-islanding protection	According to local standard			
Maximum external AC overcurrent protection	63 A	63 A	80 A	80 A
Output overvoltage protection	SPD Type II			
<b>Operating performance</b>				
Maximum efficiency ( $\mu_{max}$ )	98,4%	98,4%	98,4%	98,4%
Euro efficiency	98,2%	98,2%	98,2%	98,2%
<b>Communication</b>				
Embedded communication interfaces	Dual Ethernet port, WLAN, advanced RS-485 port (optional)			
Communication protocol	Modbus TCP Sunspec, Modbus RTU Sunspec (optional)			
User Interface	LEDs, Web User Interface, Installer APP, Display (optional)			
Cloud services	Aurora Vision <sup>®</sup> Plant Management Platform, Rest API			



## Technical data and types

Type code	PVS-20-TL (2MPPT)	PVS-20-TL (4MPPT)	PVS-30-TL	PVS-33-TL
<b>Input side</b>				
Advanced functions	Embedded export limitation control (in combination with external meter), 24h self consumption monitoring			
<b>Environmental</b>				
Ambient temperature range	-25...+60°C (-13...140 °F) with derating above 45 °C (113 °F)			
Relative humidity	4%... 100% condensing			
Maximum operating altitude	4000 m	4000 m	4000 m	4000 m (13123 ft) with derating above 3000 m (9842 ft)
<b>Physical/General</b>				
Inverter typology	Grid connected, double stage, transformerless			
Environmental protection rating	IP65			
Environmental classification	4K26 (IEC 60721-3-4)			
Cooling	Forced air			
Dimension (H x W x D)	675 (799,2 with connection boxes) x 591,8 x 227,5 mm			
Weight	50 Kg			
Mounting system	Single mounting bracket (vertical or horizontal installation)			
<b>Safety</b>				
Marking	CE, RCM			
Safety, EMC and RED standard	IEC/EN 62109-1, IEC/EN 62109-2, EN 61000-6-1, EN 61000-6-2, EN 61000-3-11, EN 61000-3-12, EN 62311, EN 301 489-1, EN 301 489-17, EN 300 328			
Grid standard (check your sales channel for availability)	IEC 61683, EN 50530, IEC 62116, IEC 61727, AS/NZS 4777.2, VDE-AR-N 4105, VDE-AR-N 4110, VDE V 0124-100, DIN VDE V 0126-1-1, VFR 2019, UTE C15-712-1, CEI 0-21, CEI 0-16, PEA, MEA, EN 50438, EN 50549-1/-2, DRRG (DUBAI), CLC/TS 50549-1/-2, G99, Synergrid C10/11, RD 413, RD 1565, RD244, P.O. 12.3, NTS 631, UNE 206006 IN (ITC-BT-40), PPDS-priloha, Denmark Type A/B, IRR-DCC-MV, ABNT NBR 16149, ABNT NBR 16150, NRS 097-2-1, SII, ISO/IEC Guide 67, Netherlands Type A, EIFS Type A, Ireland			
<b>Available product versions</b>				
Inverter equipped with SPD Type 2 on the DC and AC side	PVS-20-TL-SX	PVS-20-TL-SXD	PVS-30-TL-SX	PVS-33-TL-SX
Inverter equipped with SPD Type 1+2 on the DC side and Type 2 on the AC side	PVS-20-TL-SY	-	PVS-30-TL-SY	PVS-33-TL-SY
Inverter equipped with SPD Type 2 on the DC and AC side for IT system	-	-	-	PVS-33-TL-SI
<b>Available ordering options</b>				
PID recovery	Only for SX version	-	Only for SX version	Only for SX version
AFCI (Arc Fault Circuit Interrupter)	Only for SX version	-	Only for SX version	Only for SX version
Display	Only for SX version	-	Only for SX version	Only for SX version
<b>Additional plug-in option</b>				
PVS-20/30/33-CCB	Available	Available	Available	Available

1) 30 A for Australia and New Zealand

2) Available only with a dedicated version called "SI", with 33kW of power

3) Selecting the grid code "GERMANY (VDE 4105:2018 PNOM)" this value is limited to 20000W for PVS-20-TL and 33000W for PVS-33-TL

4) Selecting the grid code "GERMANY (VDE 4105:2018 PNOM)" this value is limited to 20000VA for PVS-20-TL and 33000VA for PVS-33-TL

5) Selecting the grid code "GERMANY (VDE 4105:2018 PNOM)" or "AUSTRALIA (AS/NZS 4777)" this value is limited to 30000W

6) Selecting the grid code "GERMANY (VDE 4105:2018 PNOM)" or "AUSTRALIA (AS/NZS 4777)" this value is limited to 30000VA

### Remarks:

- **Designed and manufactured in Italy**
- **Features not specifically listed in the present data sheet are not included in the product**

# FIMER string inverters

## PVS-50.0/60.0-TL

### 50.0 to 60.0 kW

The PVS-50/60-TL is FIMER's cloud connected three-phase string solution enabling cost efficient large decentralized photovoltaic systems for both commercial and utility applications.

This PVS string inverter family, with 3 independent MPPT and power ratings of up to 60 kW, has been designed with the objective to maximize the ROI in large systems with all the advantages of a decentralized configuration for both rooftop and ground-mounted installations.

#### Compact design

Thanks to technological choices aimed at optimizing installation times and costs, the product design features the power module and wiring box enclosed in a single compact chassis thus saving installation resources and costs.

The inverter comes in multiple versions also allowing the possibility to connect to third-party DC string combiners.

#### Ease of installation

The horizontal and vertical mounting possibility creates flexibility for both rooftop and ground mounted installations. Moreover the cover is equipped with hinges and locks that are fast to open and reduce the risk of damaging the chassis and interior components when commissioning and performing maintenance actions.

#### Advanced cloud connected features

Standard wireless access from any mobile device makes the configuration of inverter and plant easier and faster. Improved user experience thanks to a built-in User Interface (UI) enables access to advanced inverter configuration settings.

The Installer for Solar Inverters mobile app and configuration wizard enable a quick multi-inverter installation, saving up to 70% commissioning time.

#### Fast system integration

Industry standard Modbus (RTU/TCP)/SUNSPEC protocol enables fast system integration. Two ethernet ports enable fast and future-proof communication for PV plants.

#### Plant portfolio integration

Monitoring your assets is made easy, as every inverter is capable to connect to Aurora Vision cloud platform to secure your assets and profitability in long term.

#### Highlights

- Up to 3 independent MPPT
- Two power ratings: 50 kW at 400 V<sub>ac</sub> and 60 kW at 480 V<sub>ac</sub>
- Horizontal and vertical installation
- Easy access to wiring box thanks to hinges and cam latches positioned on cover
- Power module and wiring box in a single compact chassis
- Wi-Fi interface for commissioning and configuration
- Reactive power management capability
- Remote monitoring and firmware upgrade via Aurora Vision cloud platform (logger free)
- Provides 10% extra power in case of limited ambient temperature
- Improved operating altitude. Can work up to 4000 mt.
- Built-in dynamic export limitation control algorithm
- FIMER PowerGain yield optimization
- Energy community ready



FIMER PVS-50.0/60.0 block diagram

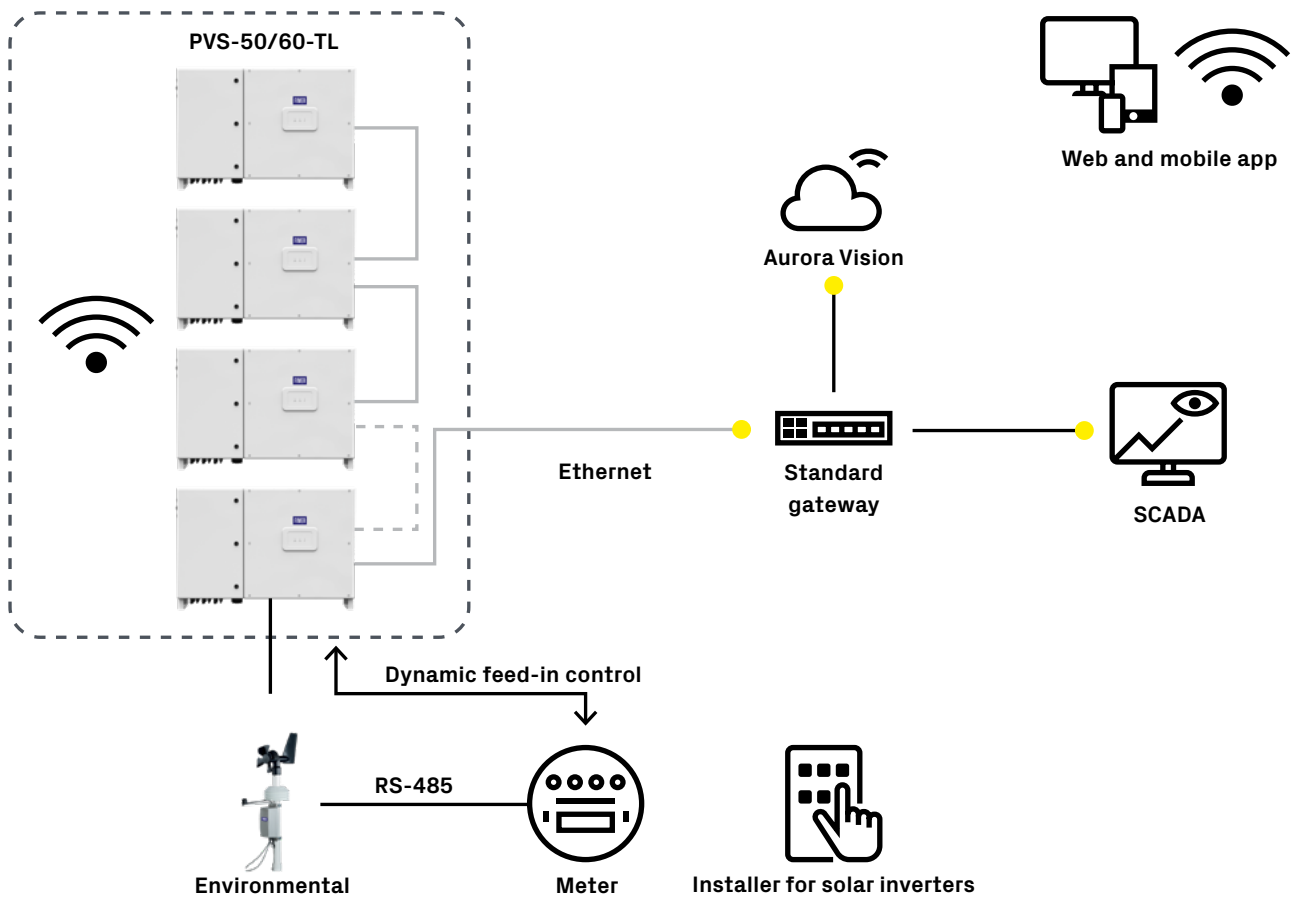

## Technical data and types

Type code	PVS-50-TL	PVS-60-TL
<b>Input side</b>		
Absolute maximum DC input voltage ( $V_{max,abs}$ )		1000 V
Start-up DC input voltage ( $V_{start}$ )	420...700 V (Default 420 V)	420...700 V (Default 500 V)
Operating DC input voltage range ( $V_{dcmin}...V_{dcmax}$ )	0,7x $V_{start}$ ...950 V (min 300 V)	0,7x $V_{start}$ ...950 V (min 360 V)
Rated DC input voltage ( $V_{dc,r}$ )	610 Vdc	720 Vdc
Rated DC input power ( $P_{dc,r}$ )	52000 W	61800 W
Number of independent MPPT	3 (version SX and SX2) / 1 (standard version)	
Maximum DC input power for each MPPT ( $P_{MPPTmax}$ )	19300W@30°C / 17500W@45°C	23100W@30°C / 21000W@45°C
MPPT input DC voltage range ( $V_{MPPTmin} ... V_{MPPTmax}$ ) at $P_{acr}$	480-800 Vdc	570-800 Vdc
Maximum DC input current ( $I_{dc,max}$ ) for each MPPT	36 A	
Maximum input short circuit current for each MPPT	55 A (165 A in case of parallel MPPT)	
Number of DC input pairs for each MPPT	5 (SX and SX2 versions), 1 (standard version)	
DC connection type	Screw terminal block (Standard version) or PV quick fit connector <sup>1)</sup> (SX and SX2 version)	
<b>Input protection</b>		
Reverse polarity protection	Yes, from limited current source	
Input over voltage protection for each MPPT	Type 2 / Type 1 + 2 (option)	
Photovoltaic array isolation control	According to local standard	
DC switch rating for each MPPT	75 A / 1000 V for each MPPT (SX and SX2 version)	
Fuse rating (version with fuses) / max fuse rating	15 A, 20 A, 25 A <sup>2)</sup>	
<b>Output side</b>		
AC grid connection type	Three-phase (3W+PE or 3W+N+PE), grounded WYE system only	
Rated AC power ( $P_{acr} @\cos\phi=1$ )	50000 W	60000 W
Maximum AC output power ( $P_{ac,max} @\cos\phi=1$ )	55000 W up to 30°C <sup>3)</sup>	66000 W up to 30°C <sup>3)</sup>
Maximum apparent power ( $S_{max}$ )	55000 VA up to 30°C <sup>3)</sup>	66000 VA up to 30°C <sup>3)</sup>
Rated AC grid voltage ( $V_{ac,r}$ )	400 V	480 V
AC voltage range	320...480 V <sup>3)</sup>	384...571 V <sup>4)</sup>
Maximum AC output current ( $I_{ac,max}$ )	80 A	
Contributory fault current	92 A	
Rated output frequency ( $f_r$ )	50 Hz / 60 Hz	
Output frequency range ( $f_{min}...f_{max}$ )	47...53 Hz / 57...63 Hz <sup>5)</sup>	
Nominal power factor and adjustable range	> 0.995; 0...1 inductive/capacitive with maximum Sn	
Total current harmonic distortion	<3%	
Maximum AC cable	95mm <sup>2</sup> copper or stranded aluminum	
AC connection type	Screw terminal block, cable gland (admitted cable diameter 25...44mm)	
<b>Output protection</b>		
Anti-islanding protection	According to local standard	
Maximum external AC overcurrent protection	100 A	
Output overvoltage protection	Type 2	
<b>Operating performance</b>		
Maximum efficiency ( $\eta_{max}$ )	98.4%	98.6%
Euro efficiency	98.2%	98.4%
<b>Communication</b>		
Embedded communication interfaces	3x RS-485, 2X Ethernet (RJ45), WLAN (IEEE802.11 b/g/n @ 2.4 GHz)	
Communication protocol	Modbus RTU / TCP (Sunspec compliant); Aurora Protocol	
Remote monitoring services	Standard level access to Aurora Vision monitoring portal	
Advanced features	Integrated Web User Interface; Embedded logging and direct transferring of data to Cloud	

## Technical data and types

Type code	PVS-50-TL	PVS-60-TL
<b>Environmental</b>		
Ambient temperature range	-25...+60°C (-13...140 °F) with derating above 45 °C (113 °F) with derating above 45 °C (113 °F)	
Relative humidity	4%... 100% condensing	
Sound pressure level, typical	75 dB(A) @1 m	
Maximum operating altitude	4000 m (13123 ft) with derating above 2000 m / 6561 ft	
<b>Physical</b>		
Environmental protection rating	IP65	
Cooling	Forced air	
Dimension (H x W x D)	750 mm x 1100 mm x 257 mm / 29.5" x 43.3" x 10.12"	
Weight	70 kg / 154 lbs (SX version)	
Mounting system	Single mounting bracket	
<b>Safety</b>		
Marking	CE	
Safety and EMC standard	IEC/EN 62109-1, IEC/EN 62109-2, EN 61000-6-2, EN 61000-6-3, EN 61000-3-11, EN 61000-3-12 EN 62311, EN 301 489-1, EN 301 489-17, EN 300 328	
Grid standard (check your sales channel for availability)	CEI 0-21, CEI 0-16, DIN V VDE V 0126-1-1, VDE-AR-N 4105, G59/3, DRRG/DEWA, EN 50438, RD 1565, RD 413, UTE C15-7-712-1 P.O. 12.3, AS/NZS 4777.3, BDEW, NRS-097-2-1, MEA, PEA, IEC 61727, ISO/IEC Guide 67 (System 5) IEC 61683, VFR-2014, IEC 62116, Synergrid C10/11, IRR-DCC-MV, CLC-TS-50549-1/-2, G99, EN 50549-1/-2	
<b>Available product versions</b>		
Input connections with terminal blocks + surge arrester Type 2 in both DC and AC sides	PVS-50-TL	PVS-60-TL
15 quick Input connections + fuses (single pole) + DC switch + surge arresters Type 2 in both DC and AC sides	PVS-50-TL-SX	PVS-60-TL-SX
15 quick Input connections + fuses (both poles) + DC switch + surge arresters Type 2 in both DC and AC sides	PVS-50-TL-SX2	PVS-60-TL-SX2
<b>Available options</b>		
SPD Type 1 + 2 on the DC side	Only for SX2 version	Only for SX2 version
Display	For all versions	For all versions
<b>Additional plug-in</b>		
PVS-50/60-GROUNDING KIT	Available	Available

- 1) Please refer to the document "String inverters – Product manual appendix" available at [www.fimer.com](http://www.fimer.com) for information on the quick-fit connector brand and model used in the inverter.
- 2) 25 A fuses can be used with a limited number of inputs, only up to 3 per channel. The inverter equipped with the desired fuse size can be ordered through dedicated part.
- 3) Due to country specific regulation this value can be automatically limited to the rated value (50kW for PVS-50-TL, 60kW for PVS-60-TL). This limitation

- can also be set manually through the integrated Web User Interface.
- 4) The AC voltage range may vary depending on specific country grid standards.
  - 5) The Frequency range may vary depending on specific country grid standards.

#### Remarks:

- **Designed and manufactured in Italy**
- **Features not specifically listed in the present data sheet are not included in the product**

# FIMER string inverters

## PVS-100/120-TL

### 100 to 120 kW

The PVS-100/120-TL is FIMER's cloud connected three-phase string solution for cost efficient decentralized photovoltaic systems for both ground mounted and large commercial applications.

This platform, for extreme high power string inverters with power ratings up to 120 kW, maximizes the ROI for decentralized ground mounted and large rooftop applications. With up to six MPPT, energy harvesting is optimized even in shading situations.

#### **Extreme power with high integration level**

The extreme high power module up to 120 kW saves installation resources as less units are required. Due to its compact size further savings are generated in logistics and in maintenance. Thanks to the integrated DC/AC disconnection, 24 string connections, fuses and surge protection no additional boxes are required.

#### **Ease of installation**

The horizontal and vertical mounting possibility creates flexibility for both ground mounted and rooftop installations. Covers are equipped with hinges and locks that are fast to open and reduce the risk of damaging the chassis and interior components when commissioning and performing maintenance actions.

Standard wireless access from any mobile device makes the configuration of inverter and plant easier and faster. Improved user experience thanks to a built in User Interface (UI) enables access to advanced inverter configuration settings.

The installer mobile APP, available for Android/iOS devices, further simplifies multi-inverter installations.

The design supports both copper and aluminum cabling even up to 185 mm<sup>2</sup> cross section to minimize the energy losses.

#### **Fast system integration**

Industry standard Modbus/SUNSPEC protocol enables fast system integration. Two ethernet ports enable fast and future proof communication for PV plants.

#### **Plant portfolio integration**

Monitoring your assets is made easy as every inverter is capable to connect to Aurora Vision cloud platform to secure your assets and profitability in long term.

#### **Design flexibility and shade tolerance**

Available in different versions, thanks to the double stage conversion topology and the modular design, PVS-100/120 guarantees maximum flexibility for the system design on rooftops or hilly ground. The separate and configurable wiring compartment, available with six MPPT as well as with two parallelable MPPT, allows the inverter to satisfy any plant condition and any customer need.

With this technological choice energy harvesting is optimized even in shading situations.

#### **Highlights**

- Up to 6 independent MPPT
- Transformerless inverter
- 120 kW for 480 Vac and 100 kW for 400 Vac
- Wi-Fi as standard for configuration
- Two ethernet ports for plant level communication
- Large set of specific grid codes available which can be selected directly in the field
- Double stage topology for a wide input range
- Both vertical and horizontal installation
- Separate wiring compartment for fast swap and replacement
- IP66 Environmental protection
- Maximum efficiency up to 98.9%
- FIMER PowerGain yield optimization
- Energy community ready



FIMER PVS-100/120 block diagram

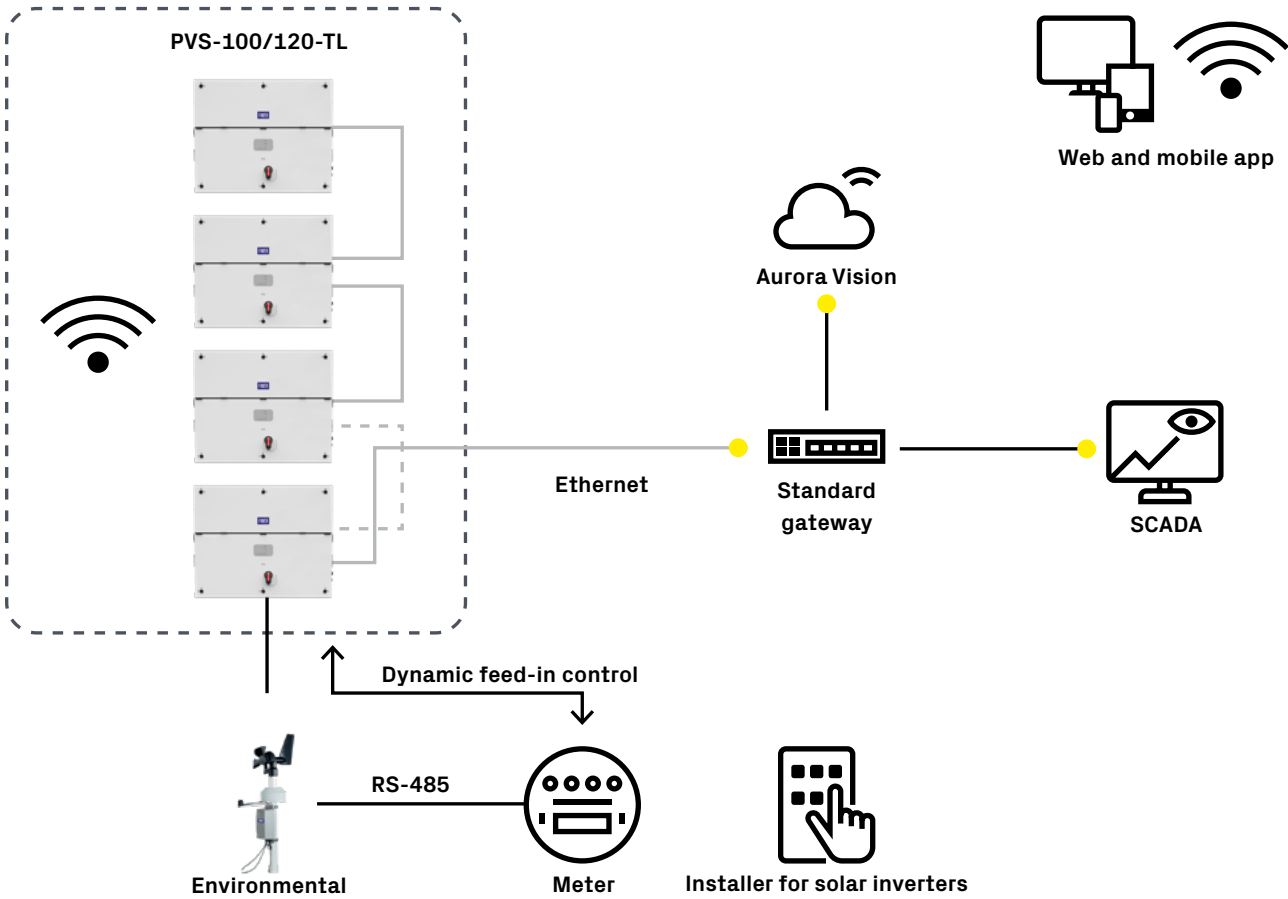

## Technical data and types

Type code	PVS-100-TL			
Wiring Box version	SX, SX2	SY, SY2	Standard	S2
<b>Input side</b>				
Absolute maximum DC input voltage ( $V_{max,abs}$ )	1000 V			
Start-up DC input voltage ( $V_{start}$ )	420 V (400...500 V)			
Operating DC input voltage range ( $V_{dcmin...V_{dcmax}}$ )	360...1000 V			
Rated DC input voltage ( $V_{dcr}$ )	620 V			
Rated DC input power ( $P_{dcr}$ )	102000 W			
Number of independent MPPT	6		2 (Paralleleable)	
MPPT input DC voltage range at ( $V_{MPPTmin...V_{MPPTmax}}$ ) at $P_{dcr}$	480...850 V (symmetrical load)			
Maximum DC input power for each MPPT ( $P_{MPPT,max}$ )	21000 W [585 V ≤ VMPPT ≤ 850 V]		63000 W [585 V ≤ VMPPT ≤ 850 V]	
Maximum DC input current for each MPPT ( $I_{dcr,max}$ )	36 A		108 A	
Maximum input short circuit current ( $I_{sc,max}$ ) for each MPPT <sup>1)</sup>	50 A		150 A	
Number of DC input pairs for each MPPT	4		1	
DC connection type	PV quick fit connector <sup>2)</sup>		4 x M40 cable glands (Ø 19...28mm) with M10 Cable lugs	
<b>Input protection</b>				
Reverse polarity protection	Yes, from limited current source			
Input over voltage protection for each MPPT-surge arrester with monitoring	Type II	Type I+II	Type II	
Photovoltaic array isolation control	Yes, acc. to IEC 62109-2			
Residual Current Monitoring Unit (leakage current protection)	Yes, acc. to IEC 62109-2			
DC switch rating for each MPPT	50 A-1000 V		Not present	150 A-1000V
Fuse rating (versions with fuses)	20 A / 1000 V <sup>3)</sup>		No fuses inside	
Input current monitoring	Single string level (24ch.): SX2, SY2 / MPPT level: Standard, S2, SX, SY			
<b>Output side</b>				
AC Grid connection type	Three phase 3W+PE or 4W+PE			
Rated AC power ( $P_{acr} @ \cos\phi=1$ )	100000 W			
Maximum AC output power ( $P_{ac,max} @ \cos\phi=1$ )	100000 W			
Maximum apparent power ( $S_{max}$ )	100000 VA			
Rated Apparent Power (Sr)	100000 VA			
Rated AC grid voltage ( $V_{acr}$ )	400 V			
AC voltage range	320...480 V <sup>4)</sup>			
Maximum AC output current ( $I_{acr,max}$ )	145 A			
Rated output current	145 A			
Output inrush current (peak and duration)	10% of $I_{max}$ for 5 msec			
Rated output frequency ( $f_r$ )	50 Hz / 60 Hz			
Output frequency range ( $f_{min...f_{max}}$ )	45...55 Hz / 55...65 Hz <sup>5)</sup>			
Nominal power factor and adjustable range	> 0.995, 0...1 inductive/capacitive with maximum $S_{max}$			
Total current harmonic distortion	< 3%			
Max DC Current Injection (% of $I_n$ )	< 0.5%* $I_n$			
Maximum AC cable	185mm <sup>2</sup> Aluminum and copper			
AC connection type	Provided bar for lug connections M10, single core cable glands 4xM40 and M25, multi core cable gland M63 as option			
<b>Output protection</b>				
Anti-islanding protection	According to local standard			
Maximum external AC overcurrent protection	225 A			
Output overvoltage protection - replaceable surge protection device	Type 2 with monitoring			
<b>Operating performance</b>				
Maximum efficiency ( $\eta_{max}$ )	98.4%			
Weighted efficiency (EURO)	98.2%			
<b>Communication</b>				
Embedded communication interfaces	1x RS485, 2x Ethernet (RJ45), WLAN (IEEE802.11 b/g/n @ 2.4 GHz)			
User interface	4 LEDs, Web User Interface			
Communication protocol	Modbus RTU/TCP (Sunspec compliant)			
Commissioning tool	Web User Interface, Mobile APP/APP for plant level			
Remote monitoring services	Aurora Vision <sup>®</sup> monitoring portal			
Advanced features	Embedded logging, direct telemetry data transferring to Aurora Vision			
<b>Environmental</b>				
Operating ambient temperature range	-25...+60°C / -13...140°F with derating above 40°C / 104°F			
Relative humidity	4%...100% condensing			
Sound pressure level, typical	68dB(A)@ 1m			
Maximum operating altitude without derating	2000 m / 6560 ft			



## Technical data and types

Type code	PVS-100-TL			
Wiring Box version	SX, SX2	SY, SY2	Standard	S2
<b>Physical</b>				
Environmental protection rating	IP 66 (IP54 for cooling section)			
Cooling	Forced air			
Dimension (H x W x D)	869x1086x419 mm / 34.2" x 42.7" x 16.5"			
Weight	70kg / 154 lbs for power module ; ~55kg / 121 lbs for wiring box Overall max 125 kg / 276 lbs			
Mounting system	Mounting bracket vertical & horizontal support			
<b>Safety</b>				
Isolation level	Transformer-less			
Marking	CE, RCM			
Safety and EMC standard	IEC/EN 62109-1, IEC/EN 62109-2, EN 61000-6-2, EN 61000-6-4			
Grid standard (check your sales channel for availability)	CEI 0-16, CEI 0-21, IEC 61727, IEC 62116, IEC 60068, IEC 61683, JORDAN IRR-DCC-MV, DRRG/DEWA, Chile LV/MV, Belg C10-C11, EN50438 Generic +Ireland, EN50549-1/2, CLC-TS50549-1/2, AS/ NZS4777.2, UK G59/3, EREC G99-1, MEA, PEA, ISO-IEC Guide 67 (system 5), NRS 097-2-1, P.O. 12.3, ITC-BT-40, UNE 206006 IN, VDE-AR-N 4105, VDE-AR-N 4110, VDE-AR-N 4120, VDE V 0-126-1-1, VFR 2019, UTE C15-712-1, Taiwan			
<b>Available products variants</b>				
Inverter power module	PVS-100-TL-POWER MODULE			
Input with 24 quick fit connectors pairs + String fuses (both positive and negative pole) + DC disconnect switches + AC disconnect switch + AC and DC overvoltage surge arresters (Type II) + individual string monitoring (24 ch.)	WB -SX2-PVS-100-TL			
Input with 24 quick fit connectors pairs + String fuses (positive pole) + DC disconnect switches + AC and DC overvoltage surge arresters (Type II) + MPPT level input current monitoring (6 ch.)	WB -SX-PVS-100-TL			
Input with 24 quick fit connectors pairs + String fuses (both positive and negative pole) + DC disconnect switches + AC disconnect switch + AC and DC overvoltage surge arresters (Type II for AC and Type I+II for DC) + individual string monitoring (24 ch.)	WB -SY2-PVS-100-TL			
Input with 24 quick fit connectors pairs + String fuses (positive pole) + DC disconnect switches + AC and DC overvoltage surge arresters (Type II for AC and Type I+II for DC) + MPPT level input current monitoring (6 ch.)	WB -SY-PVS-100-TL			
Input with cable gland + DC disconnect switch + AC disconnect switch + AC and DC overvoltage surge arresters (Type II) + MPPT level input current monitoring	WB-S2-PVS-100-TL			
Input with cable gland + AC and DC overvoltage surge arresters (Type II) + MPPT level input current monitoring	WB-PVS-100-TL			
<b>Optional available</b>				
AC Plate, Single Core Cables	Plate with 5 individual AC cable glands: 4 x M40: Ø 19...28mm, 1 x M25: Ø 10...17mm			
AC Plate, Multi Core Cables	Plate with 2 individual AC cable glands: 1 x M63: Ø 37...53mm, 1 x M25: Ø 10...17mm			
PVS-100/120 Pre-Charge Board Kit	Night time operation with restart capability			
PVS-100/120 Grounding Kit <sup>6)</sup>	Allow to connect the negative input pole to ground			

- Maximum number of opening 5 under overloading
- Please refer to the document "String inverters – Product manual appendix" available at [www.fimer.com](http://www.fimer.com) for information on the quick-fit connector brand and model used in the inverter
- Maximum fuse size supported 20A. Additionally two strings input per MPPT supports 30A fuse size for connecting two strings per input
- The AC voltage range may vary depending on country specific country grid standard
- The Frequency range may vary depending on specific country grid standards

6) When grounding-kit is installed, Residual Current Monitoring does not fully operate. Inverter must be installed and operate in "restricted areas (access limited to qualified personnel)" according to IEC 62109-2

#### Remarks:

- Designed and manufactured in Italy
- Features not specifically listed in the present data sheet are not included in the product

## Technical data and types

Type code	PVS-120-TL			
Wiring Box version	SX, SX2	SY, SY2	Standard	S2
<b>Input side</b>				
Absolute maximum DC input voltage ( $V_{max,abs}$ )	1000 V			
Start-up DC input voltage ( $V_{start}$ )	420 V (400...500 V)			
Operating DC input voltage range ( $V_{demin}...V_{demax}$ )	360...1000 V			
Rated DC input voltage ( $V_{dcr}$ )	720 V			
Rated DC input power ( $P_{acr}$ )	123000 W			
Number of independent MPPT	6		2 (Parallelable)	
MPPT input DC voltage range at ( $V_{MPPTmin}...V_{MPPTmax}$ ) at $P_{acr}$	570...850 V (symmetrical load)			
Maximum DC input power for each MPPT ( $P_{MPPT,max}$ )	25000 W [695 V $\leq$ VMPPT $\leq$ 850 V]		75000 W [695 V $\leq$ VMPPT $\leq$ 850 V]	
Maximum DC input current for each MPPT ( $I_{dmax}$ )	36 A		108 A	
Maximum input short circuit current ( $I_{sc,max}$ ) for each MPPT <sup>1)</sup>	50 A		150 A	
Number of DC input pairs for each MPPT	4		1	
DC connection type	PV quick fit connector <sup>2)</sup>		4 x M40 cable glands ( $\varnothing$ 19...28mm) with M10 Cable lugs	
<b>Input protection</b>				
Reverse polarity protection	Yes, from limited current source			
Input over voltage protection for each MPPT-surge arrester with monitoring	Type II	Type I-II	Type II	
Photovoltaic array isolation control	Yes, acc. to IEC 62109-2			
Residual Current Monitoring Unit (leakage current protection)	Yes, acc. to IEC 62109-2			
DC switch rating for each MPPT	50 A-1000 V		Not present	150 A
Fuse rating (versions with fuses)	20 A / 1000 V <sup>3)</sup>		No fuses inside	
Input current monitoring	Single string level (24ch.): SX2, SY2 / MPPT level: Standard, S2, SX, SY			
<b>Output side</b>				
AC Grid connection type	Three phase 3W+PE or 4W+PE			
Rated AC power ( $P_{acr}@cos\phi=1$ )	120000 W			
Maximum AC output power ( $P_{ac,max}@cos\phi=1$ )	120000 W			
Maximum apparent power ( $S_{max}$ )	120000 VA			
Rated Apparent Power (Sr)	120000 VA			
Rated AC grid voltage ( $V_{ac,r}$ )	480 V			
AC voltage range	384...576 <sup>4)</sup>			
Maximum AC output current ( $I_{ac,max}$ )	145 A			
Rated output current	145 A			
Output inrush current (peak and duration)	10% of $I_{max}$ for 5 msec			
Rated output frequency (f)	50 Hz / 60 Hz			
Output frequency range ( $f_{min}...f_{max}$ )	45...55 Hz / 55...65 Hz <sup>5)</sup>			
Nominal power factor and adjustable range	> 0.995, 0...1 inductive/capacitive with maximum $S_{max}$			
Total current harmonic distortion	< 3%			
Max DC Current Injection (% of $I_n$ )	< 0.5% * $I_n$			
Maximum AC cable	185mm <sup>2</sup> Aluminum and copper			
AC connection type	Provided bar for lug connections M10, single core cable glands 4xM40 and M25, multi core cable gland M63 as option			
<b>Output protection</b>				
Anti-islanding protection	According to local standard			
Maximum external AC overcurrent protection	225 A			
Output overvoltage protection - replaceable surge protection device	Type 2 with monitoring			
<b>Operating performance</b>				
Maximum efficiency ( $\eta_{max}$ )	98.9%			
Weighted efficiency (EURO)	98.6%			
<b>Communication</b>				
Embedded communication interfaces	1x RS485, 2x Ethernet (RJ45), WLAN (IEEE802.11 b/g/n @ 2.4 GHz)			
User interface	4 LEDs, Web User Interface			
Communication protocol	Modbus RTU/TCP (Sunspec compliant)			
Commissioning tool	Web User Interface, Mobile APP/APP for plant level			
Remote monitoring services	Aurora Vision <sup>®</sup> monitoring portal			
Advanced features	Embedded logging, direct telemetry data transferring to Aurora Vision <sup>®</sup>			
<b>Environmental</b>				
Operating ambient temperature range	-25...+60°C / -13...140°F with derating above 40°C / 104°F			
Relative humidity	4%...100% condensing			
Sound pressure level, typical	68dB(A)@ 1m			
Maximum operating altitude without derating	2000 m / 6560 ft			

## Technical data and types

Type code	PVS-120-TL			
Wiring Box version	SX, SX2	SY, SY2	Standard	S2
<b>Physical</b>				
Environmental protection rating	IP 66 (IP54 for cooling section)			
Cooling	Forced			
Dimension (H x W x D)	869x1086x419 mm / 34.2" x 42.7" x 16.5"			
Weight	70kg / 154 lbs for power module ; ~55kg / 121 lbs for wiring box. Overall max 125 kg / 276 lbs			
Mounting system	Mounting bracket vertical & horizontal support			
<b>Safety</b>				
Isolation level	Transformer-less			
Marking	CE			
Safety and EMC standard	IEC/EN 62109-1, IEC/EN 62109-2, EN 61000-6-2, EN 61000-6-4 CEI 0-16, IEC 61727, IEC 62116, IEC 60068, IEC 61683, JORDAN IRR-DCC-MV, DRRG/DEWA, Chile MV, Belg C10-C11, EN50438 Generic +Ireland, EN50549-2, CLC-TS50549-2, UK G59/3, EREC G99-1, PEA, ISO-IEC Guide 67 (system 5), NRS 097-2-1, P.O. 12.3, ITC-BT-40, UNE 206006 IN, VDE-AR-N 4110, VDE-AR-N 4120, VDE V 0-126-1-1,VFR 2019, UTE C15-712-1, Taiwan			
Grid standard (check your sales channel for availability)				
<b>Available products variants</b>				
Inverter power module	PVS-120-TL-POWER MODULE			
Input with 24 quick fit connectors pairs + String fuses (both positive and negative pole) + DC disconnect switches + AC disconnect switch + AC and DC overvoltage surge arresters (Type II) + individual string monitoring (24 ch.)	WB -SX2-PVS-120-TL			
Input with 24 quick fit connectors pairs + String fuses (positive pole) + DC disconnect switches + AC and DC overvoltage surge arresters (Type II) + MPPT level input current monitoring (6 ch.)	WB -SX-PVS-120-TL			
Input with 24 quick fit connectors pairs + String fuses (both positive and negative pole) + DC disconnect switches + AC disconnect switch + AC and DC overvoltage surge arresters (Type II for AC and Type I+II for DC) + individual string monitoring (24 ch.)	WB -SY2-PVS-120-TL			
Input with 24 quick fit connectors pairs + String fuses (positive pole) + DC disconnect switches + AC and DC overvoltage surge arresters (Type II for AC and Type I+II for DC) + MPPT level input current monitoring (6 ch.)	WB -SY-PVS-120-TL			
Input with cable gland + DC disconnect switch + AC disconnect switch + AC and DC overvoltage surge arresters (Type II) + MPPT level input current monitoring	WB-S2-PVS-120-TL			
Input with cable gland + AC and DC overvoltage surge arresters (Type II) + MPPT level input current monitoring	WB-PVS-120-TL			
<b>Optional available</b>				
AC Plate, Single Core Cables	Plate with 5 individual AC cable glands: 4 x M40: Ø 19...28mm, 1 x M25: Ø 10...17mm			
AC Plate, Multi Core Cables	Plate with 2 individual AC cable glands: 1 x M63: Ø 37...53mm, 1 x M25: Ø 10...17mm			
PVS-100/120 Pre-Charge Board Kit	Night time operation with restart capability			
PVS-100/120 Grounding Kit <sup>6)</sup>	Allow to connect the negative input pole to ground			

- 1) Maximum number of opening 5 under overloading
- 2) Please refer to the document "String inverters – Product manual appendix" available at [www.fimer.com](http://www.fimer.com) for information on the quick-fit connector brand and model used in the inverter
- 3) Maximum fuse size supported 20A. Additionally two strings input per MPPT supports 30A fuse size for connecting two strings per input
- 4) The AC voltage range may vary depending on country specific country grid standard
- 5) The Frequency range may vary depending on specific country grid standards

6) When grounding-kit is installed, Residual Current Monitoring does not fully operate. Inverter must be installed and operate in "restricted areas (access limited to qualified personnel)" according to IEC 62109-2

#### Remarks:

- **Designed and manufactured in Italy**
- **Features not specifically listed in the present data sheet are not included in the product**

# FIMER PowerGain

Photovoltaic systems are generally designed and placed to guarantee a constant sun irradiation. However, it is not possible to completely avoid shading situations, which end up reducing the power production.

FIMER has developed an algorithm - FIMER PowerGain - applying to the whole string inverter portfolio, which optimizes the yield of any PV system even under shading conditions and without the need of any external devices, hence boosting the return on your investment.

Indeed, thanks to FIMER PowerGain, the inverter scans the input voltage and, within milliseconds, identifies the absolute maximum power point, so as to avoid chasing relative maximum power points, namely what a traditional inverter equipped with standard MPPT would do, hence resulting in less power produced.

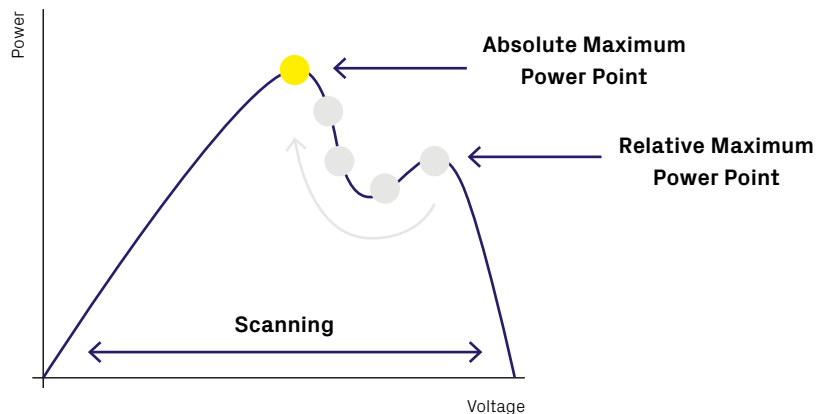
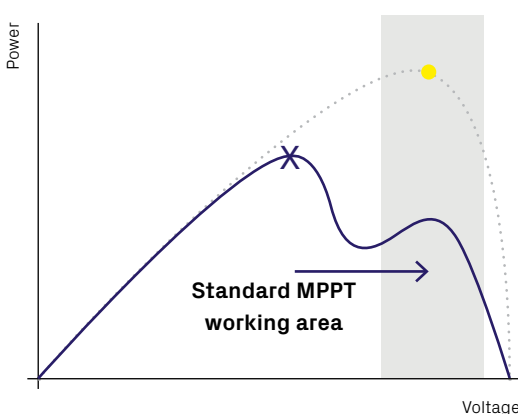
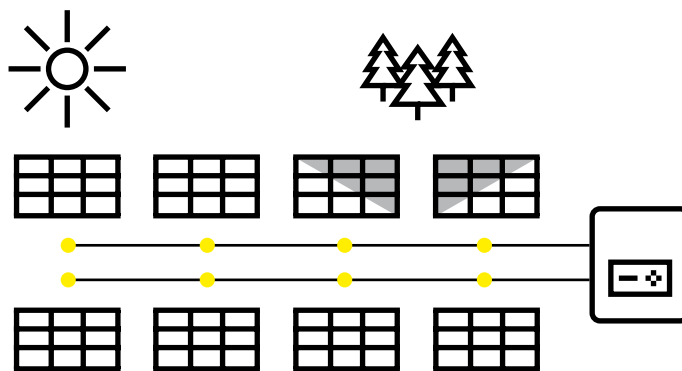

DC optimizers installed at module level are also used in order to mitigate the negative impact of shading. However, such solution requires several additional components to be installed underneath each panel, being exposed to humidity

and temperature changes, increasing both the possibility of failure and installation costs.

With FIMER string inverters, such approach is no longer necessary, FIMER PowerGain does the job!

# Maximize your energy production with FIMER PowerGain

A smart function allowing efficient shade management. Integrated in any FIMER string inverter:

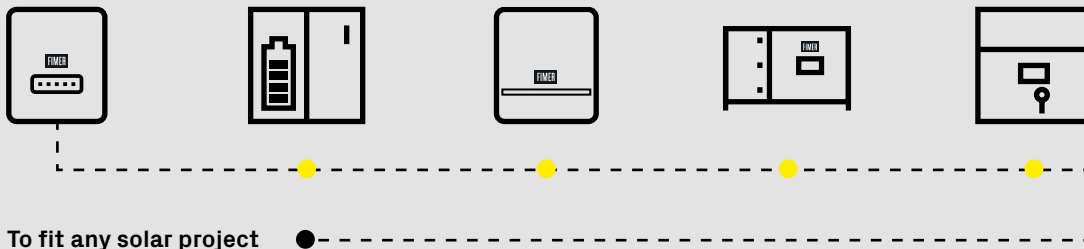

Residential



Commercial



Industrial



Trackers



Carports

## Benefits

### Ease of installation and maintenance



No additional components needed



Lower risk of component failure

### Maximum flexibility



Built-in any FIMER string inverter model and size



The interval between scans can be chosen based on project requirements

### Optimal performance



Up to 10% higher yields compared to PV systems applying traditional inverters



Highest energy production over a long period compared to DC optimizers



**Boost your energy production now**  
**Stronger. Better. FIMER.**

# Export limitation solution

The new generation of FIMER PVS-string inverters is even more smart thanks to the innovative built-in distributed control algorithm which allows meeting export limits without the need of installing any additional system or device\*.

The new innovative FIMER Export limitation solution allows solar plant owners to get the maximum energy from their inverters, without the need to invest in additional external systems, and is compliant with the export limits set by grid operators and utilities worldwide. It is the only IP based solution currently on the market\*\* that does not require the installation of any additional components besides PVS series string inverters and a supported and standard modbus meter, allowing for great advantage in terms of both investments and ownership costs, plant reliability and system complexity.

All PVS series string inverters come with an innovative distributed control algorithm built-in which, once quickly configured through the Installer for solar inverters app set-up wizard, allows the entire plant to dynamically follow the load curves in compliance with the most restrictive regularity norms worldwide.

To get the solution properly configured and working, the supported standard meter needs to be installed at the point of connection and paired to the inverters just once, by either direct RS-485 serial line, to the inverter's serial port, or over Ethernet (Local Area Network).

According to the specific meter installed, the new FIMER

export limitation algorithm can work indistinctly in small commercial installations, with just a few inverters connected to the low voltage stage, as well as in a large commercial/utility-scale plants, where up to maximum 15 units (a higher number of units may be authorized upon request) per plant are connected to the grid by middle voltage stage.

## Highlights

- IP based solution
- Distributed control algorithm built-in the inverter just standard meter needed and no external controller required
- PVS string inverters supported (15 units per plant)
- Just a standard Modbus meter (either RS-485 or Ethernet) needed
- System setting through the Installer for solar inverters mobile app
- Fully integrated with Aurora Vision cloud
- Control can be activated on both low and medium point of connection
- High performance control solution
- Compliant with modern regulatory norms worldwide (such as: AS/NZS 4777.2:2015, G100, Thailand MEA)
- Failsafe mechanism allow to respect of the limit set at the energy exported to grid even in case of fault occurred to the inverter or meter

\* With the exception of a standard Modbus meter from the ones supported.

\*\* To date

\*\*\* 40 units achievable on request

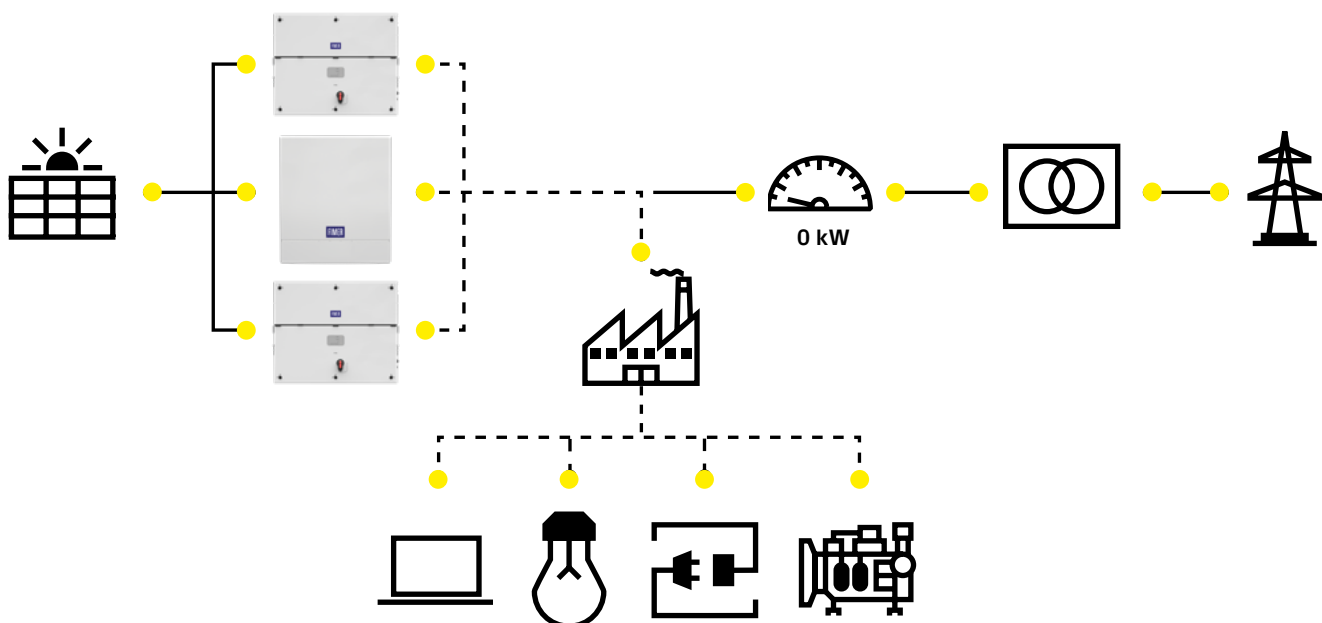

# Monitoring and control solutions

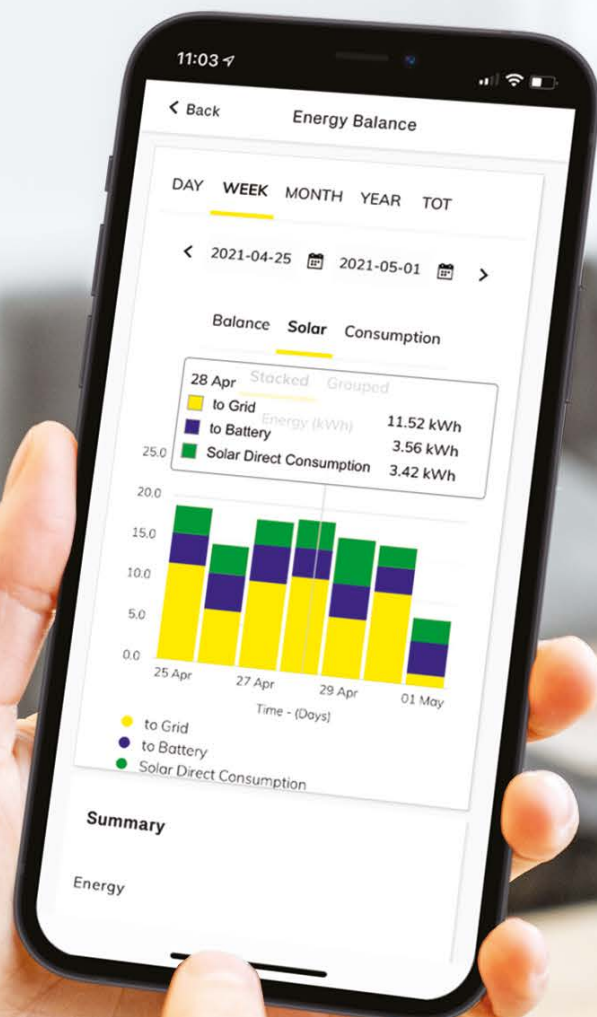

# Aurora Vision®

Aurora Vision® is a scalable, secure and reliable cloud-based platform that allows customers to remotely manage and analyze the main key performance indicators of their solar power plants as well as use advanced diagnostics tools, in all market segments. This cloud-based solution, accessible through an Aurora Vision® account, is structured to offer multiple services and products all designed with specific customer needs in mind:

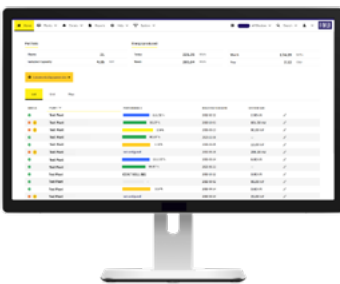

## Plant Portfolio Manager

An advanced professional webportal that allows stakeholders (such as installers/ operators/ managers) to monitor and control fleets of photovoltaic systems installed for final customers.



## Energy Viewer

A smart and easy-to-use mobile app for monitoring the main power generation and self-performances indicators, for owners of residential and commercial PV plants, in order to keep energy use and savings in check.

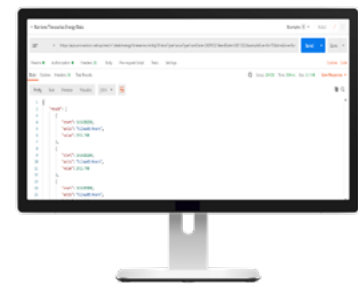

## Aurora Vision® APIs

Harness the power of data from FIMER's photovoltaic systems to design solutions and provide opportunities.

### Monitoring to improve your productivity

Real-time data acquisition, early fault detection and email alerting are some of the key features that will help to reduce maintenance and prevent the occurrence of failures.

Thanks to the granularity of the string-level monitoring and intelligent fault descriptions, detailed analyses can be extrapolated that lead to the type of repair needed by also determining the potential spare parts to be used, thus minimizing inconclusive interventions.

With the availability of professional diagnostic tools such as Plant Performance and Assets Diagnostic charts that have been carefully designed, combined with comprehensive asset management and the ability to perform remote firmware upgrades, it is easy to positively impact maintenance operations thus optimizing costs and providing great benefits in terms of customer satisfaction.

Finally, thanks to the administration tools, solar professionals can administer an entire portfolio of solar plants by managing both the lifecycle of solar assets and the accounts of employees and customers.

### Versatility to achieve energy independence

Aurora Vision's versatility and cross-integration allows homeowners to benefit directly from the platform, simply by choosing to self-register their PV system or by having their solar power plant registration handled directly by their trustworthy installer.

Everything is easily accessible through iOS and/or Android systems (both tablets and smartphones) without the need to install any additional software or perform data back-ups; by leveraging the power of FIMER inverter data everything is managed through the Aurora Vision® cloud-based platform. The products provided are designed with modular and easy-to-use dashboards, offering all the main data at your fingertips.

Users can therefore start to optimize their own self-performances, leading to have a clear assessment of all energy flows and household consumption.



# Aurora Vision® Energy Viewer

Energy Viewer allows solar power plants owners to remotely monitor the main power generations indicators as well as all the energy flows and the self-performances of their own PV plants, with or without an energy storage system installed, “At-A-Glance”

Energy Viewer allows you to perform energy management from anywhere you want, thanks to easy-to-use and easy-to-view dashboards, for a portfolio of residential to commercial scale power-plants:

- Visualize all the energy flows that enters and exits the main subjects involved in the solar power plant ecosystem, thanks to a 360° synoptic view with a dynamic responsive shaping based on the physical plant layout; \*
- Easily monitor your system's output and home's consumption, keeping your energy use and savings in check, thanks to dedicated Self-Performances KPIs; \*
- Control active and closed events of your PV plant, thanks to a dedicated dashboard and the dynamic responsive shaping of the synoptic; \*
- Update your firmware remotely, wherever you are;

## A Free Comprehensive Solution

Energy Viewer is integrated with all FIMER inverters, with or without an energy storage system installed, and is available for free for all plants using FIMER inverters.

All dashboards are scalable, offering different views for all needs.

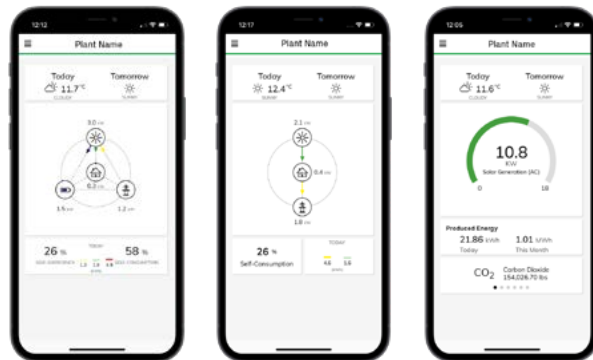

\* available only with a supported bi-directional meter installed

## For all your favorite devices

Energy Viewer App is downloadable from App Store, Google Play Store and it is compatible with iOS (11.0 or better) and Android (7.0 -Nougat - or better).

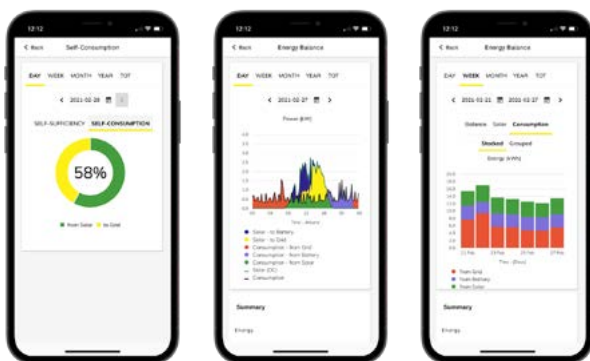

## Comprehensive Energy Management

Analyze all the details you want, for every subject involved in your solar power plant ecosystem. Watch your consumption rise and fall, including historical usage.

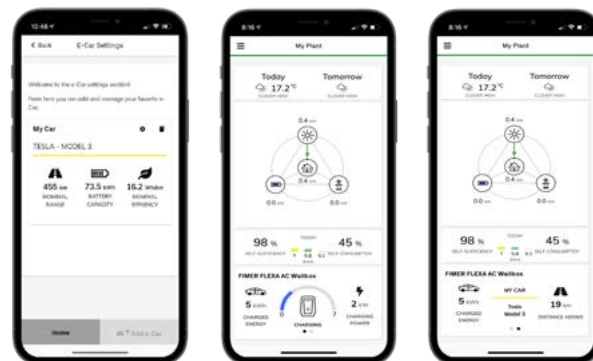

## Integrated Electric Mobility

Enter the new era of EVI thanks to an integrated solution with FIMER FLEXA AC Wallbox: configure and manage your favorite e-car to know the main nominal data while charging, remotely monitor charging process and trends.

# Aurora Vision®

## Plant Portfolio Manager

Plant Portfolio Manager is a cloud based professional web portal enabling to monitor key energy and performance metrics and manage an entire portfolio of solar power plant.

Plant Portfolio Manager have all the tools needed to set-up, monitor, operate and administer a portfolio of residential to utility scale power-plants:

- Create new customer accounts, setup new power plants and provision monitoring at a given plant;
- Configure, operate and troubleshoot devices throughout your portfolio of power plants;
- Generate custom and scheduled reports for billing, finance and customers;
- Remotely upgrade inverter firmware;
- Evaluate the performances of the solar plant and detect real time under performing conditions;
- Manage inverters, loggers, combiners, weather stations and sensors used in a solar power plant;
- Manage plant sites, customer accounts and privileges within a portfolio. You can also take advantage of these features at an organizational level, in order to manage a fleet of portfolios.

### Free monitoring for FIMER inverters

The standard access to Plant Portfolio Manager is available for free, for all plants using FIMER inverters, via an authorized Aurora Vision account.

### Cross-integrative collaboration

Share and use remote diagnostic Aurora Vision tools to collaboratively resolve solar power plant issues, impacting downwards costs and time. The integration with Energy Viewer allows continuous assistance to the owner, of one or more solar power plants, in order to optimize consumption and revenues.

### Extensible and modular solution

Plant Portfolio Manager is integrated with all FIMER inverters and a broad array of 3rd party vendors. It provides out-of-the-box integration with meters, sensors, weather stations and combiners guaranteeing fast and cost effective enablement of plant operations management.



### Plant performance and device diagnostics

Analyze electrical and environmental characteristics of assets such as FIMER inverters, meters, string combiners, weather stations and sensors. Optimize operation and maintenance functions for a specific plant using performance information to rapidly identify and resolve issues.

### Plant status monitoring

Define, customize and assign error profiles to monitor plant status and perform detailed troubleshooting. Assign email containers to interconnect stakeholders interested in plant(s) statuses.

### Plant assets management lifecycle

Manage type, location and performance configuration of plant and/or individual devices for compliance, control and performance objectives.

### Customizable reports

Use standard or custom reports with various performance criteria for a single plant, a set of plants or the entire portfolio. Reports can be executed once or scheduled on a time-frame basis and can be exported in standard formats (CSV, Excel™).

# Installer for solar inverters

## Installer for solar inverters

The Installer for solar inverters mobile app allows installers of large-scale solar plants to commission multiple inverters simultaneously, easily and effectively.

This mobile app allows a single installer to finalize the commissioning of up to 50 inverters at a time with a saving of up to 80% of the average commissioning time experienced. Multi-inverter commissioning, FW update, network forming, export limitation setting up and secured access to the app by any valid Aurora Vision account give the Installer for solar inverters the title of essential professional tool for commissioning any modern solar plant.

## Highlights

- Claiming inverter via QR code scanning
- Up to 50 inverters commissioned at a time
- Automatic assigning of both static IP address and RS-485 slave ID
- Multi-inverter FW update
- Intuitive plant detting up wizard procedure
- Export Limitation setting up
- Monitoring device setting up
- Works on iOS (version 11.x or greater) and Android (version 6.0.1.x or greater) devices
- Export Limitation solution setting up

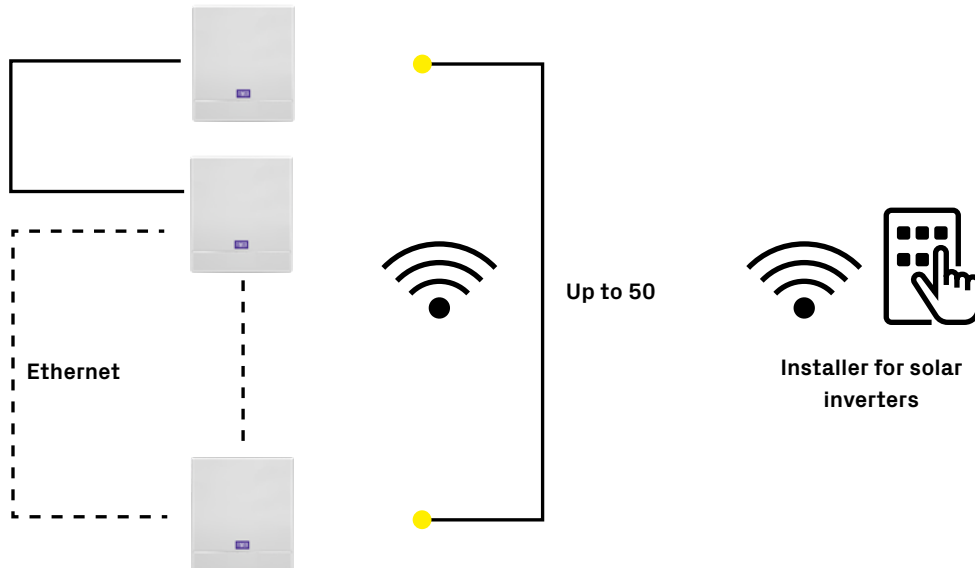

# VSN300 Wifi Logger Card: Wi-Fi connectivity and monitoring integrated into the inverter

The VSN300 Wifi Logger Card is an expansion board for FIMER's compatible<sup>1)</sup> UNO, PVI and TRIO string inverter families which provides residential and commercial inverter owners with an advanced and cost-effective solution for monitoring the performance and the status of their photovoltaic system.



The VSN300 Wifi Logger Card is an accessory expansion board adding Wi-Fi connectivity and an advanced data logger to those FIMER string inverter not featuring such capabilities already integrated.

The VSN300 Wifi Logger Card is easy to install, by using the internal expansion slot available in most of FIMER's UNO, PVI and TRIO inverter families.

The built-in IP connectivity and the intuitive configuration wizard allow owner to connect its own inverter to any existing Wi-Fi network and so to use one of the available Aurora Vision's cloud products enabling remote monitoring of the photovoltaic system.

The VSN300 Wifi Logger Card comes with an integrated web user interface enabling the user to get wireless access to the main parameters of the inverters by any Wi-Fi enabled device and common web browser.

Combining the VSN300 Wifi Logger Card with the mobile app FIMER Plant Viewer for Mobile inverter owners are enabled to use their own mobile devices (smartphone or tablet)

as the local display of the inverter and get real time info about parameters, performance and status of their solar plant without using the Internet.

The Wi-Fi Certified™ mark along with the the intuitive configuration wizard assure interoperability, security, easy installation and reliability.

## Highlights

- The Wi-Fi Certified™ mark assures interoperability with IEEE 802.11b/g/n networks over the 2.4 GHz band
- Easily installed on most UNO, PVI and TRIO inverter families
- Remote monitoring via Aurora Vision® products
- High performance non-volatile data logging
- Local inverter monitoring in combination with the mobile app Plant Viewer for Mobile
- SunSpec Modbus TCP for easy integration with third party monitoring systems
- Encrypted data transfer to Aurora Vision® cloud platform

1) Please refer to the document "Accessories compatibility matrix" available at [www.fimer.com](http://www.fimer.com) for information on the compatible models and/or devices.

# Plant Viewer for Mobile

Plant Viewer for Mobile gives solar power plant owners a flexible and cost-effective solution for monitoring their solar inverter while “on-the-go”.



**Plant Viewer for Mobile delivers an easy way to monitor, both locally and remotely, your home solar power system on an iOS/Android smart phone or tablet**

With Plant Viewer for Mobile, homeowners can remotely monitor their solar power plants to track the energy produced in real time.

## **Customize, collaborate, and monitor energy production**

Solar plant owner homeowners have the choice of self-registering their FIMER's inverter site to privately monitor their home energy production. As an alternative, homeowners can collaborate with installers to share energy generation data to jointly monitor their energy production.

## **Local Display**

A key feature of Plant Viewer for Mobile is its capability to communicate wirelessly with the FIMER's VSN300 Wifi Logger Card in order to enable a smartphone or tablet to act as a local display of most TRIO, PVI and UNO inverters. Those who own an inverter not featuring embedded Wi-Fi connectivity and integrated data logger are hence enabled to monitor the performance and the status of their solar inverters via mobile app, without the need to use the Internet.

## **Highlights**

- Real-time energy production monitoring including, hourly and daily tracking history
- Track energy production in multiple plant locations
- View historical energy production information in excel format
- Track temperature, wind and irradiance information using add-on options sold with your solar power system
- Compatible with the latest iOS and Android devices
- Act as wireless local display for inverter with VSN300 installed in (no Internet connection needed)

Plant Viewer for Mobile is also available as desktop version, named Plant Viewer: an easy to use web portal enabling remote monitoring of the performance and the status of any residential and commercial FIMER solar plant

# Monitoring and communications

## VSN800 Weather Station

The weather stations belonging to the VSN800 family allow the monitoring of a series of environmental and panel data through Aurora Vision® cloud platform, being equipped with temperature, irradiation and wind sensors.



The VSN800 contains the essential environmental sensor set needed for solar monitoring. The expanded sensor set allows a wider monitoring of environmental parameters. VSN800 is the perfect companion to the VSN700 Data Logger products and it can directly be connected to the RS-485 port of the new PVS string inverter families.

### Shipped preconfigured and ready for installation requiring no special tools

The VSN800 Weather Station is delivered ready for installation and requires the installer to mechanically mount the modules on a user-supplied mast, connect power and communication, and initialize the automatic system commissioning process. No special software, or on-site calibration is required.

The all-in-one weather station reduces the installation, support and maintenance cost while improving the robustness and manageability of the PV plant monitoring solution.

The basic sensor set the VSN800-12 model is equipped with provides data needed to calculate a performance ratio allowing a plant operator to track solar array performance against expected energy production.

The advanced sensor set the VSN800-14 model is equipped with improves monitoring of weather conditions that can affect energy production. The additional irradiance sensor installed on the plane of the array allows for more accurate measurements of the irradiance falling onto the solar module.

The wind speed and direction sensor gives the operator information about how the wind may be cooling the panels and some indication of how much dust may be accumulating on the panels.

### Highlights

- Two models offered for basic and advanced sensor sets
- VSN800-12 includes a basic sensor set: ambient temperature, solar irradiance, and back of module temperature
- VSN800-14 comes with additional sensors compared to the basic set of VSN800-12: plane of array irradiance and wind direction and speed
- Sensors, data acquisition unit, RS-485, pre-cabled and ready to use
- Can be connected directly to the RS-485 port of either VSN700-05 Data Logger or the new PVS string inverter families.

Application with PVS string inverters

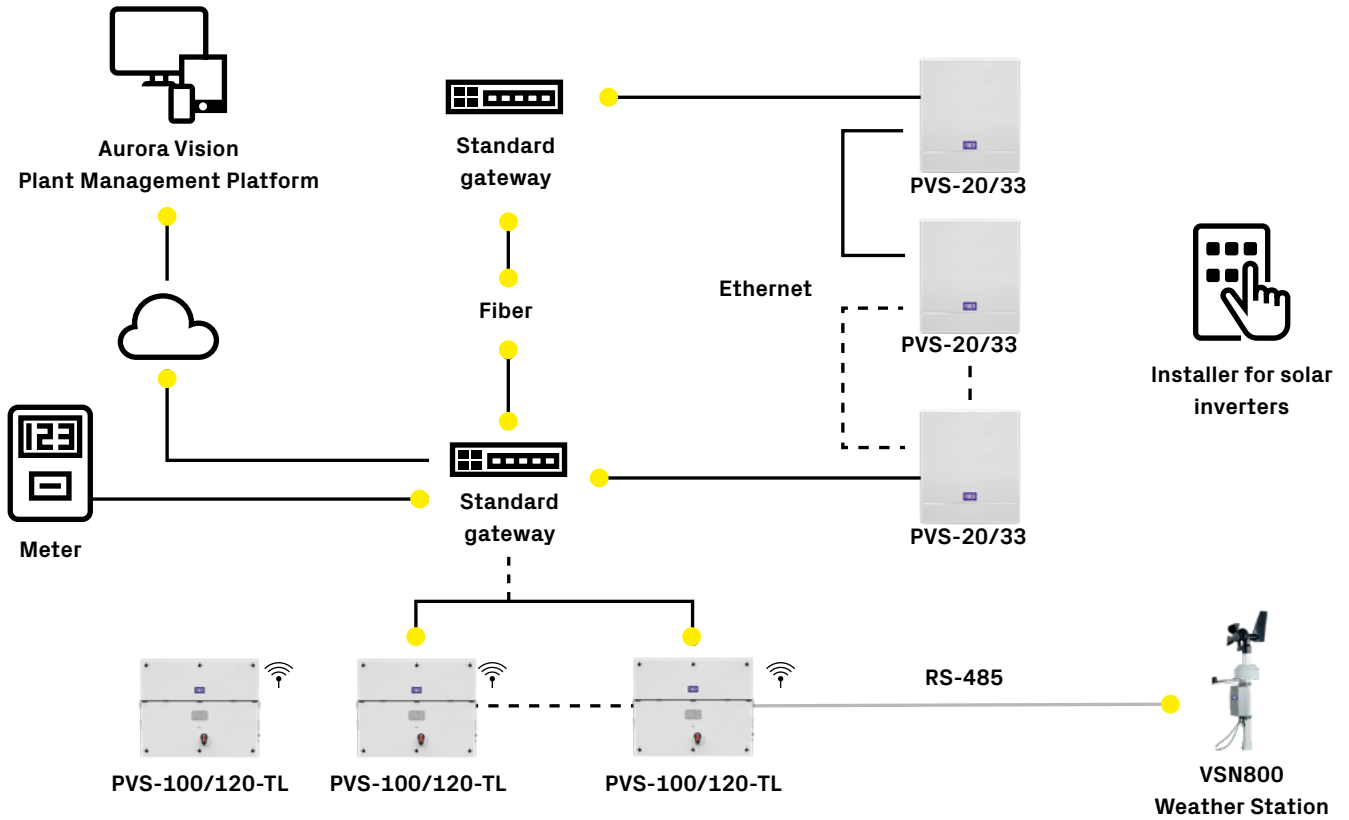

**VSN800 Weather Station sensors set supplied**

Sensor type	VSN800-12	VSN800-14
Pyranometer	Y	Y
Ambient temperature	Y	Y
Back of PV module temperature	Y	Y
Second pyranometer	N	Y
Wind speed	N	Y
Wind direction	N	Y

# Monitoring and Communications

## VSN700 Data Logger

This high-performance VSN700 data management system allows solar customers to connect their commercial, industrial and utility scale photovoltaic systems to the Aurora Vision cloud for enabling condition monitoring and O&M remote cloud services in a very cost effective manner.



This SunSpec compliant datalogger records data and events from inverters, energy meters, weather stations, and other supported photovoltaic plant devices, and acts as an Internet gateway to send the data securely and reliably to the Aurora Vision®.

### VSN700-05

The VSN700-05 Data Logger is a cost-optimized external logger enabling remote monitoring via Aurora Vision cloud products of solar plant where FIMER inverters not already featuring an embedded data logger are installed.

The VSN700-05 Data Logger is easy to install and capable to get information from FIMER inverters as well as many other supported devices (like environmental sensors and meters) connected to its two RS-485 ports or Ethernet.

Fully integrated with Aurora Vision cloud, the VSN700-05 allows residential, commercial and industrial customers to enable the condition monitoring of their FIMER solar plant, so as to maximize energy generation and to optimize self-consumption in a very easy and intuitive manner.

The VSN700-05 also provides a set of advanced functionalities making it the ideal tool to get an utility scale plant to be easily integrated with a third party monitoring and control platform.

Basic functionalities:

- Data management system with serial and Ethernet ports for data and event logging
- Quick installation and fast plug and play commissioning with device discovery mechanism
- Network Provisioning with dynamic IP addressing (DHCP client and server)
- Reliable and secure transmission of operational data to Aurora Vision cloud

Advanced functionalities:

- No software limitation on number of devices logged (up to 64 modbus device by logger)
- Modbus TCP server using SunSpec compliant Modbus maps for easy SCADA system integration, data collection, and inverter command execution
- Support for most FIMER inverters as well as a wide list of third party component like meters, smart combiners and weather stations



Application with TRIO and PVI string inverters

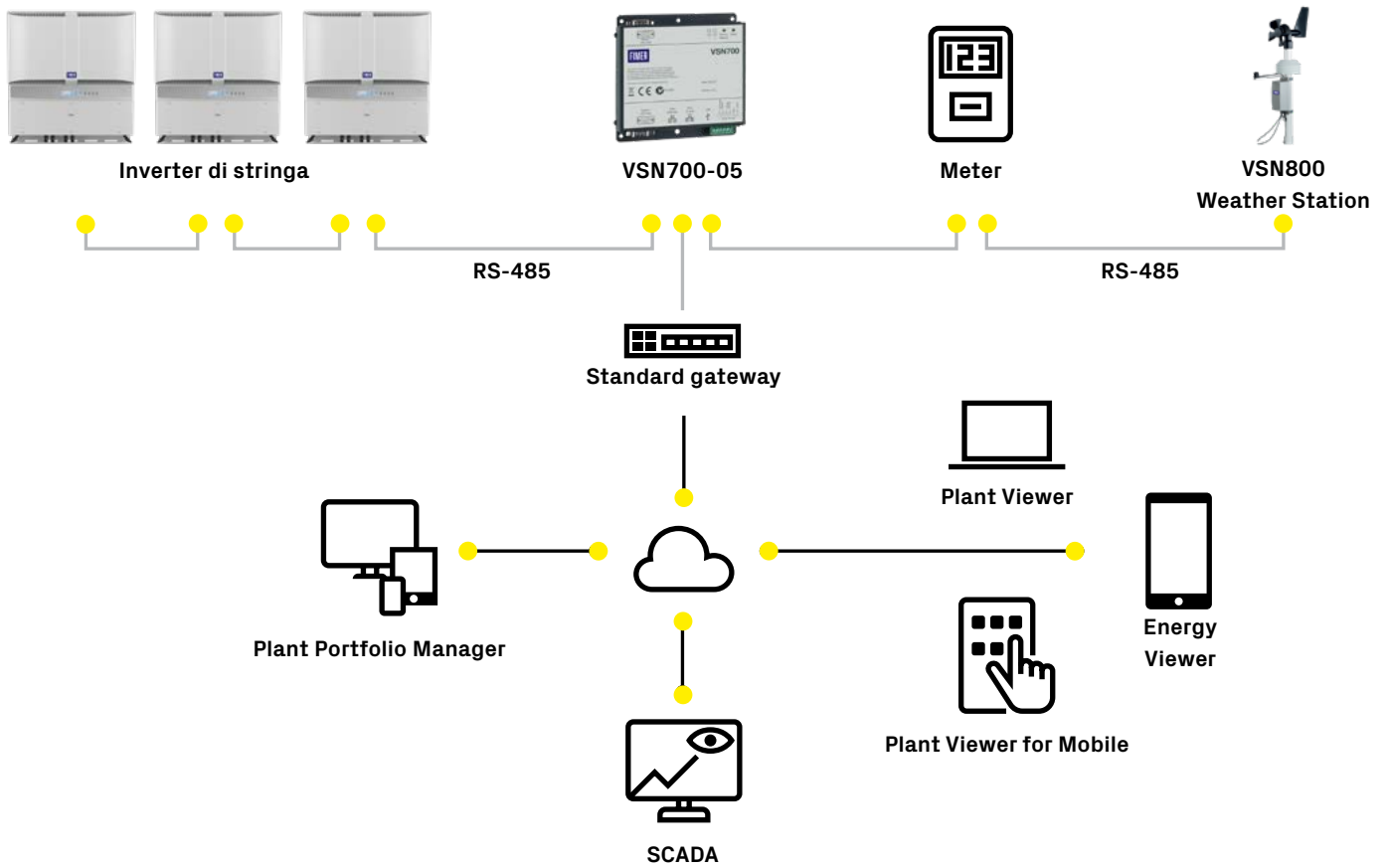

VSN700-05 specifications

Feature	VSN700-05
Logging real-time power values	1, 3, 5, 15 minute configurable intervals
Modbus/TCP server	Yes
Inverter control commands	Yes
Devices supported	All FIMER inverters <sup>1)</sup> Up to 64 Modbus (RTU) supported devices (from both FIMER and 3 <sup>o</sup> party) <sup>1)</sup>

1) Please refer to the document "Accessories compatibility matrix" available at [www.fimer.com](http://www.fimer.com) for information on the compatible models and/or devices.

Remarks:

- **Designed and manufactured in Italy**
- **Features not specifically listed in the present data sheet are not included in the product**

# Life cycle services for solar inverters. Optimizing the performance of your solar plant

The FIMER solar service offering spans over the whole lifetime of the solar power plant. Such optimum support to end users secures the value of the solar power plant assets to the owner.

## **Pre-sales**

FIMER pre-sales support helps our customers to select the right inverter and services for their applications. This ensures higher yield and performance of the entire system and compatibility with customer requirements.

## **Order and delivery**

Orders can be placed through any FIMER office, and spare parts can also be ordered online through the web. Our sales and service network offers timely deliveries worldwide.

## **Commissioning**

FIMER certified engineers can advise or undertake the commissioning of the solar inverters and supervise the installation.

## **Maintenance**

FIMER helps to ensure a long lifetime for its solar inverters by providing on-site preventive maintenance. Preventive maintenance consists of annual inspections and component replacements according to specific maintenance schedules. Reconditioning provides more in-depth maintenance which is carried out at FIMER's authorized service workshops. Reconditioning of the solar inverter includes full inspection, thorough cleaning, individual component analysis and replacement, and complete testing. A service of reactive maintenance is also available.

## **Upgrade and retrofit**

We can advise on the latest hardware and software upgrades that can continue to maximize the performance of your solar inverters even if the grid codes change.

## **Repairs**

FIMER authorized service engineers are standing by to get your equipment back on-line as soon as possible through both on-site and workshop repairs.

## **Warranty monitoring and extension**

The status of your warranty can be monitored online and it is also possible to purchase extensions of the same through the FIMER website.

## **Life cycle model**

The life cycle model divides a product's life cycle into four phases: active, classic, limited and obsolete. Each phase has different implications for the end user in terms of services provided.

## **Benefits of life cycle management**

Life cycle management maximizes the value of the solar inverter and its maintenance investments by:

- Ensuring spare parts and FIMER competence availability throughout the lifetime
- Enabling efficient product support and maintenance for improved reliability
- Adding functionality to the initial product by upgrading or retrofitting
- Providing a smooth transition to new technology at the end of the product lifetime

FIMER Solar Care, available for PVI-CENTRAL PLUS,

is a modular set of services for predictable care of your asset and peace of mind over the full lifetime of the solar plant.

The offering includes:

- Availability of spares
- Extended warranties
- Preventive maintenance
- Corrective maintenance
- Response time
- Uptime guarantee
- Training
- Technical support



# Honoring our Customers globally

Our goal is to commit and invest to reach Service Excellence, through the consistent improvement of our services. Operating in over 100 countries, we are close to our customers, taking care to understand and satisfy their needs.



## 6 Repair centers



US, Brazil, Italy, Turkey, India and Australia

## World-wide partner network



1000 Field Service Engineers including Service Partners

## On-site technical support



164 FIMER Field Service Engineers

## Immediate availability of spare parts



6 Dedicated service stocked warehouses

**Stronger. Better. FIMER.**







FIMER S.p.A.  
Via J.F. Kennedy  
20871 Vimercate (MB)  
Italy

[www.fimer.com](http://www.fimer.com)

